

CHEVROLET

1966

CORVETTE

SPECIFICATIONS

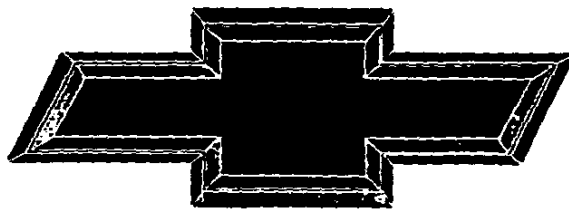
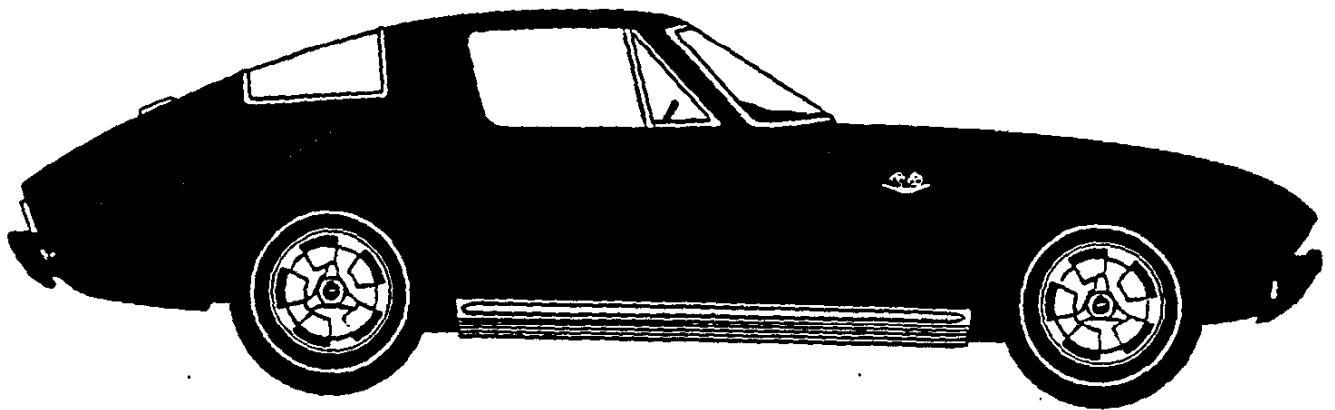

GENUINE CHEVROLET™



1
2

1

1966 OPTIONS

RPO #	DESCRIPTION	QTY	RETAILS
19437	Base Corvette Sport Coupe	9,958	\$4,295.00
19467	Base Corvette Convertible	17,762	4,084.00
—	Genuine Leather Seats	2,002	79.00
A01	Soft Ray Tinted Glass, all windows	11,859	15.80
A02	Soft Ray Tinted Glass, windshield	9,270	10.55
A31	Power Windows	4,562	57.95
A82	Headrests	1,033	42.15
A85	Shoulder Belts	37	26.35
C07	Auxiliary Hardtop (for convertible)	8,463	231.75
C48	Heater and Defroster Deletion (credit)	54	-97.85
C60	Air Conditioning	3,520	412.90
F41	Special Front and Rear Suspension	2,705	36.90
G81	Positraction Rear Axle, all ratios	24,056	42.15
J50	Power Brakes	5,464	42.15
J56	Special Heavy Duty Brakes	382	342.30
K19	Air Injection Reactor	2,380	44.75
K66	Transistor Ignition System	7,146	73.75
L36	427ci, 390hp Engine	5,116	181.20
L72	427ci, 450/425hp Engine	5,258	312.85
L79	327ci, 350hp Engine	7,591	105.35
M20	4-Speed Manual Transmission	10,837	184.35
M21	4-Speed Man Trans, close ratio	13,903	184.35
M22	4-Speed Man Trans, close ratio, heavy duty	15	237.00
M35	Powerglide Automatic Transmission	2,401	194.85
N03	36 Gallon Fuel Tank (for coupe)	66	198.05
N11	Off Road Exhaust System	2,795	36.90
N14	Side Mount Exhaust System	3,617	131.65
N32	Teakwood Steering Wheel	3,941	47.40
N36	Telescopic Steering Column	3,670	42.15
N40	Power Steering	5,611	94.80
P48	Cast Aluminum Knock-Off Wheels (5)	1,194	316.00
P92	Whitewall Tires, 7.75x15, (rayon cord)	17,969	31.30
T01	Goldwall Tires, 7.75x15 (nylon cord)	5,557	46.55
U69	AM-FM Radio	26,363	199.10
V74	Traffic Hazard Lamp Switch	5,764	11.60

- A 327ci, 300hp engine, 3-speed manual transmission, vinyl interior trim, and soft top (convertible) were included in the base price.
- The 8,463 C07 quantity included 1,303 in lieu of soft tops at no extra cost.
- The 3,520 C60 quantity was split 2,138 coupe, 1,382 convertible.
- The 2,401 M35 quantity was split 2,381 with 300hp, 20 with 390hp.
- The K19 emission device was not limited to California use.

1966 COLORS

CODE	EXTERIOR	QTY	SOFT TOP	WHEELS	INTERIORS
900	Tuxedo Black	1,190	Bk-W-Bg	Black	Bk-R-Bb-WB-S-Si-G-B
972	Ermine White	2,120	Bk-W-Bg	Black	Bk-R-Bb-WB-S-Si-G-B
974	Rally Red	3,366	Bk-W-Bg	Black	Bk-R
976	Nassau Blue	6,100	Bk-W-Bg	Black	Bk-Bb-WB-B
978	Laguna Blue	2,054	Bk-W-Bg	Black	Bk-Bb-B
980	Trophy Blue	1,463	Bk-W-Bg	Black	Bk-Bb-B
982	Mosport Green	2,311	Bk-W-Bg	Black	Bk-G
984	Sunfire Yellow	2,339	Bk-W-Bg	Black	Bk
986	Silver Pearl	2,967	Bk-W-Bg	Black	Bk-Si
988	Milano Maroon	3,799	Bk-W-Bg	Black	Bk-S

- Suggested interiors shown. Other combinations were possible.
 - In 1966, 11 Corvettes were painted non-standard colors, or primer.
- Interior Codes:** Std=Bk/V; 402=Bk/L; 407=R/V; 408=R/L; 414=Bb/V; 415=Bb/L; 418=B/V; 419=B/L; 420=S/V; 421=S/L; 426=Si/V; 427=Si/L; 430=G/V; 450=W+B/V.
- Abbreviations:** B=Blue, Bb=Bright Blue, Bg=Beige, Bk=Black, G=Green, L=Leather, R=Red, S=Saddle, Si=Silver, V=Vinyl, W=White, WB=White +Blue.



1966 CORVETTE

Production: 9,958 coupe, 17,762 convertible, 27,720 total.

1966 NUMBERS

Vehicle: 194376S100001 through 194376S127720

• For convertibles, fourth digit is a 6.

Suffix: HD: 327ci, 350hp, mt, ar IK: 427ci, 425hp, mt
HE: 327ci, 300hp, mt IL: 427ci, 390hp, mt
HH: 327ci, 300hp, mt, ar IM: 427ci, 390hp, mt, ar
HO: 327ci, 300hp, at IP: 427ci, 450/425hp, mt
HP: 327ci, 350hp, mt, ps IQ: 427ci, 390hp, at
HR: 327ci, 300hp, at, ar IR: 427ci, 390hp, at, ar
HT: 327ci, 350hp, mt KH: 327ci, 350hp, mt, ar, ac, ps

Block: 3858174: 327ci 3892657: 327ci, lp (uu)
3869942: 427ci 3855961: 427ci, ep (uu)

Head: 3782461: 327ci, 300hp, 350hp 3873858: 427ci, 450/425hp
3872702: 427ci, 390hp

Carburetor: Holley R3247A #3886101: 427ci, 450/425hp
Holley R3367A #3884505: 327ci, 300hp, 350hp
Holley R3370A #3882835: 427ci, 390hp
Holley R3605A #3890499: 327ci, 300hp, 350hp, ar
Holley R3606A #3892341: 427ci, 390hp, ar

Distributor: 1111093: 427ci, 450/425hp, ig 1111153: 327ci, 300hp
1111141: 427ci, 390hp 1111156: 327ci, 350hp
1111142: 427ci, 390hp, ig 1111157: 327ci, 350hp, ig

Alternator: 1100693: 327ci, 427ci 1100696: 327ci, 427ci, ig
1100694: 327ci, 427ci, ac 1100750: 327ci, 427ci, ac

Ending Vehicle: Sep 65: 102031 Jan 66: 112587 May 66: 123016
Oct 65: 104384 Feb 66: 115283 Jun 66: 125469
Nov 65: 107186 Mar 66: 118091 Jul 66: 127720
Dec 65: 109892 Apr 66: 120664

Abbreviations: ac=air conditioning, ar=air injection reactor,
at=automatic transmission, ci=cubic inch, ep=early production,
hp=horsepower, ig=transistor ignition, lp=late production,
mt>manual transmission, ps=power steering, uu=uncertain usage.

1966 FACTS

- The 1966 Corvette's styling was similar to the previous model. There were differences in trim, including the addition of the Corvette script (elongated vertical style) to the hood, and a new, plated, square-mesh, cast grill. Also, roof vents which had been both functional and non-functional in previous mid-year Corvette coupes, were deleted completely.
- Seats were similar to 1965, except that 1966 seats had additional pleats in the upper and lower sections for better weight distribution at the seams.
- The knock-off wheel option continued in 1966, but with a dull-finish center cone instead of bright. The area between the fins was dark grey.
- The 427 cubic-inch engines were introduced in the 1966 model. All with 427 engines received special hoods. The high performance, solid-lifter 427 was initially listed at 450hp but, for reasons unclear, the rating (not the actual output) was reduced to 425hp shortly after introduction. Also, the 390hp engine was sometimes rated at 400hp.
- Backup lights became standard equipment in the 1966 model. They were incorporated into the existing rear inboard taillight housings.
- The fiberboard headliners of coupes and convertible hardtops (except early) were replaced with vinyl-covered foam. Headrests were available for the first time. Interior door pulls were bright metal.

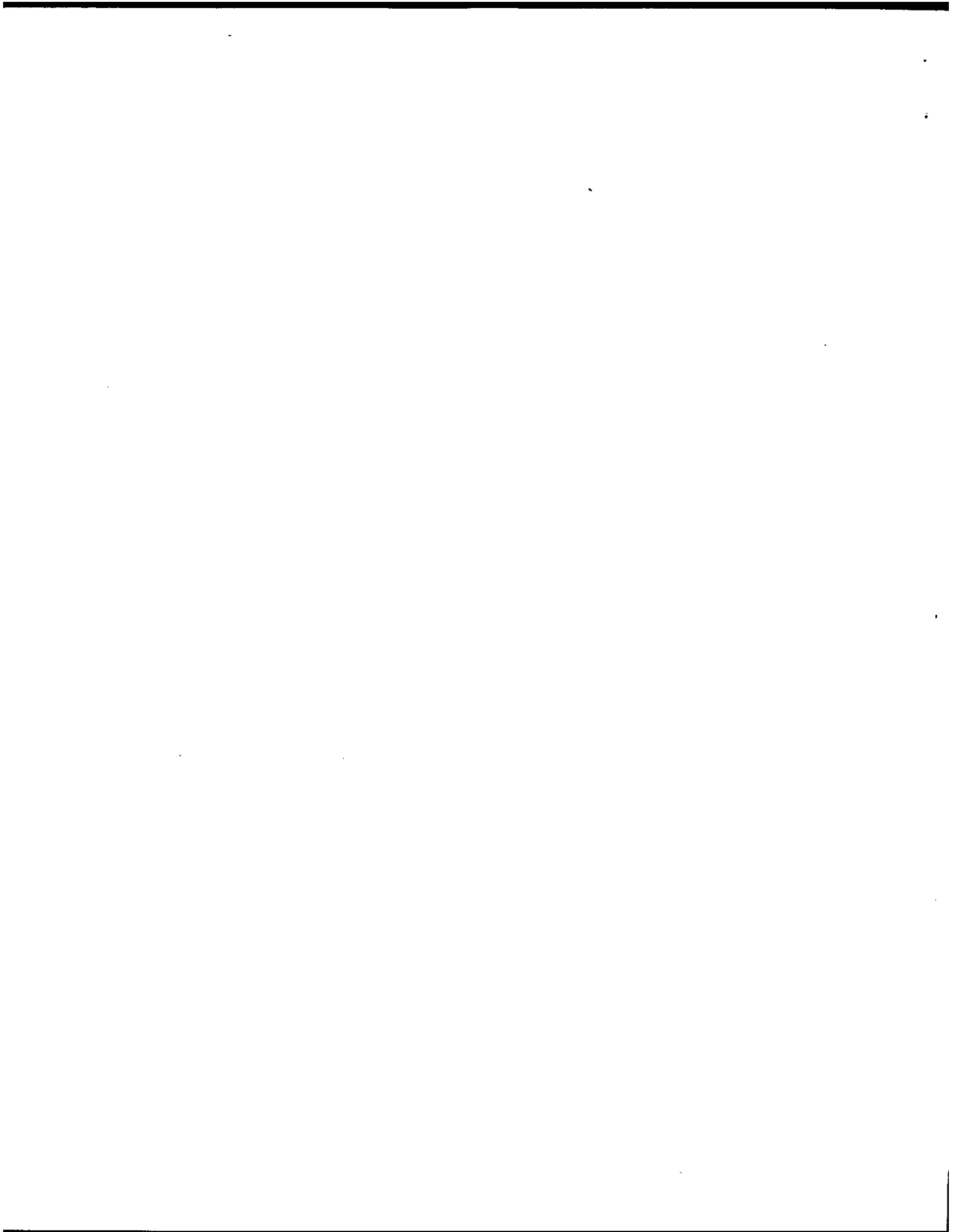

The Corvette Black Book

1953-1993

October 1992

Published by

Michael Bruce Associates, Inc.

Michael Antonick, President
Post Office Box 396
Powell, Ohio 43065



CONTENTS	
Glossary	4
1965 Corvette	44
1966 Corvette	76
1967 Corvette	78
1968 Corvette	80
1969 Corvette	82
1970 Corvette	84
1971 Corvette	86
1972 Corvette	88
1973 Corvette	90
1974 Corvette	92
1975 Corvette	94
1976 Corvette	96
1977 Corvette	98
1978 Corvette	100
1979 Corvette	104
1980 Corvette	124
1981 Corvette	76
1982 Corvette	78
1983 Corvette	80
1984 Corvette	82
1985 Corvette	84
1986 Corvette	86
1987 Corvette	88
1988 Corvette	90
1989 Corvette	92
1990 Corvette	94
1991 Corvette	96
1992 Corvette	98
1993 Corvette	100
Notes	104
Photos/Specs	104
Literature	124
Coupons	127

© Michael Bruce Associates, Inc., 1978, 1980, 1983, 1985, 1988, 1991, 1992. All rights reserved under Pan American and Universal Copyright Conventions by Michael Bruce Associates, Inc. Reproduction without permission is prohibited. Because of the possibility of errors, exceptions, or other reasons for inaccuracy, the publisher and author disclaim responsibility for the accuracy of any or all information presented in this publication.

Michael Bruce Associates, Inc. acknowledges with appreciation the following enthusiasts who contributed their expertise to this and previous editions of the Corvette Black Book: Noland Adams, Dan Aldridge, John Angwert, Pat Baker, Jane Bartheime, Michele Baling, Ken Brooks, Barry Brown, David Burroughs, Steve Dangremond, Dr. M. F. Dobbins, Bob Eckles, the late Sam Foiz, John Hibbert, Mike Hunt, Alan Kaplan, Paul Kitcher, Gary Konner, Ralph Kramer and staff, Jim Krugloff, Gary Lisk, Bill Locke, Bob Lojewski, Bob McDorman, Chip Miller, Bill Mock, Brian Pearce, John Poloney, Bill Rhodes, Jeffrey Smith, Mark & Dixie Smith, Lou Vitale, Jerry Wadsworth, Jerry Weichers and Don Williams. Thanks also to Callaway Engineering, to Mercury-Marine, and to the Chevrolet Motor Division of General Motors Corporation.

Notice: The Corvette Black Book and its publisher, Michael Bruce Associates, Inc. have no relationship or connection whatever with Hearst Business Media Corporation, its parent or affiliated corporations, or the Black Book published by National Auto Research Division of Hearst Business Media Corporation.

Michael Bruce Associates, Inc. and the Corvette Black Book are not associated with or sponsored by General Motors or its Chevrolet Motor Division.

Cover: Photo and design by Mike Antonick. 1963 Corvette owned by Bill Munzer; restored by Bill Munzer and Don Williams
Printed and bound in the United States of America.

ISBN: 0-933534-35-3

BOOK TRADE DISTRIBUTION BY:
McGraw-Hill Information
Publishers & Distributors, Inc.
Oceola, Wisconsin 54020, USA

BLACK BOOK ORDER FORM

Send _____ copies of the

Corvette Black Book 1953-1993

@ \$11.95 each \$ _____

Ohio residents add .72 sales tax _____

Postage/hard shipping container 3.00 _____

Check or money order enclosed \$ _____

Name _____

Street _____

City _____ State _____ Zip _____

Mail Order To: Michael Bruce Associates, Inc.
Post Office Box 396
Powell, Ohio 43065



BLACK BOOK ORDER FORM

Send _____ copies of the

Corvette Black Book 1953-1993

@ \$11.95 each \$ _____

Ohio residents add .72 sales tax _____

Postage/hard shipping container 3.00 _____

Check or money order enclosed \$ _____

Name _____

Street _____

City _____ State _____ Zip _____

Mail Order To: Michael Bruce Associates, Inc.
Post Office Box 396
Powell, Ohio 43065



VEHICLE IDENTIFICATION NUMBER

CHEVROLET
19467S100001

Commonly referred to as the VIN NUMBER, this series of numbers and letters is embossed on a metal plate riveted to a horizontal body support under the glove box door. (See Serial Plate Warning and Serial and Vehicle Identification Plate Variations).

FIRST DIGIT: Identifies the Chevrolet Division
(1 = Chevrolet)

SECOND & THIRD DIGITS: Identify the series
(94 = Corvette)

FOURTH & FIFTH DIGITS: Identify the body style

BODY STYLE	CODE
2-Door Sport Coupe.....	37
2-Door Convertible.....	67

SIXTH DIGIT: Identifies the model year (6 = 1966)

SEVENTH DIGIT: Identifies the assembly plant
(S = St. Louis, MO)

LAST SIX DIGITS: Represent the basic production number.
Starting number 100001 to 127720.

BODY NUMBER PLATE

Located on the crossbrace under the dash, it identifies the month and day built, model year, body style, body number, trim combination and paint color.

<table border="0" style="width: 100%;"> <tr> <td style="width: 50%; text-align: center;"> H12 STYLE 66 467 TRIM STD </td> <td style="width: 5%; text-align: center; border-left: 1px solid black; border-right: 1px solid black;"> </td> <td style="width: 45%; text-align: center;"> S 1234 BODY 974 PAINT </td> </tr> <tr> <td colspan="3" style="text-align: center; padding-top: 5px;"> BODY BY CHEVROLET </td> </tr> </table>	H12 STYLE 66 467 TRIM STD		S 1234 BODY 974 PAINT	BODY BY CHEVROLET		
H12 STYLE 66 467 TRIM STD		S 1234 BODY 974 PAINT				
BODY BY CHEVROLET						

EXAMPLE:

H12 Build Date (April 12th)
 66 Model Year (1966)
 467 Body Style (Convertible)
 S Body Manufacturer (St. Louis)
 1234 Body Number
 STD Trim Combination (Black Vinyl)
 974 Paint Color (Rally Red)

THE BUILD DATE identifies the month and day the vehicle was built.

ST. LOUIS:

MONTH	CODE
September, 1965.....	A
October.....	B
November.....	C
December.....	D
January, 1966.....	E
February.....	F
March.....	G
April.....	H
May.....	I
June.....	J
July.....	K

A.O. SMITH:

MONTH	CODE
August, 1965.....	A
September.....	B
October.....	C
November.....	D
December.....	E
January, 1966.....	F
February.....	G
March.....	H
April.....	I
May.....	J
June.....	K
July.....	L

BODY STYLE

BODY STYLE	CODE
Coupe.....	437
Convertible.....	467

BODY MANUFACTURER

MANUFACTURER	CODE
St. Louis.....	S
A.O. Smith.....	A

THE BODY NUMBER is the production serial number of the body.

THE TRIM NUMBER is the key to the trim color and material.

COLOR	VINYL	LEATHER	CODE
Black	.		STD
Black		.	402
Red	.		407
Red		.	408
Bright Blue	.		414
Bright Blue		.	415
Dark Blue	.		418
Dark Blue		.	419
Saddle	.		420
Saddle		.	421
Silver/Black	.		426
Silver/Black		.	427
Green	.		430
Green		.	431
White/Black	.		437
White/Blue	.		450
White/Blue		.	451

THE PAINT CODE is the key to the exterior paint color.

COLOR	CODE
Tuxedo Black	900
Ermine White	972
Rally Red	974
Nassau Blue	976
Laguna Blue.....	978
Trophy Blue	980
Mosport Green.....	982
Sunfire Yellow	984
Silver Pearl	986
Milano Maroon	988

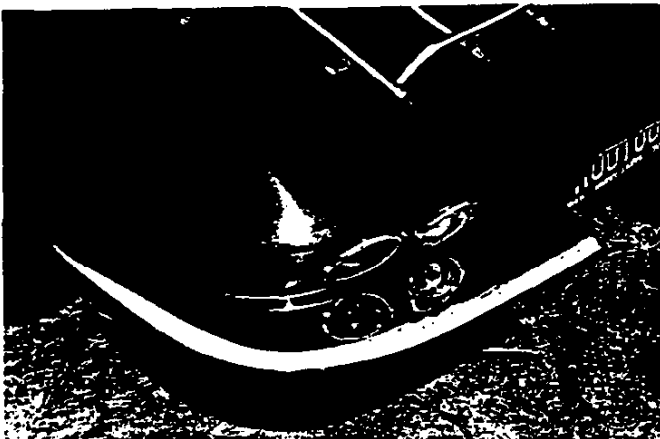

THE ENGINE NUMBER is located on a raised part actually an extension of the head mounting surface - on right front of the engine block. All Chevrolet Corvette engines are stamped with an assembly plant code, month and year produced and engine application suffix. (See Engine Assembly Plant Code Variations).

EXAMPLE: F01181HE

F..... Flint Plant
 01..... Month built (January)
 18..... Day built (18th)
 HE..... Engine Type 327", 300 HP

ASSEMBLY PLANT

Tonawanda.....
 Flint (motor)

ENGINE NO. HORSE- COMP.

CODE	CYL	CID	POWER	RATIO	CARB	TRAN
HE.....	8	327	300	10.5:1	4 BC	MAN/MA
HH.....	8	327	300	10.5:1	4 BC	MAN/AI
HR.....	8	327	300	10.5:1	4 BC	AUTO/AI
HD.....	8	327	350	11.0:1	4 BC	MAN/SHP/AI
HO.....	8	327	300	10.5:1	4 BC	AUT
HT.....	8	327	350	11.0:1	4 BC	MAN/SH
HP.....	8	327	350	11.0:1	4 BC	MAN/P
KH.....	8	327	350	11.0:1	4 BC	MAN/SHP/AI
IK.....	8	427	425	11.0:1	4 BC	MAN/SH
IL.....	8	427	390	10.25:1	4 BC	MAN/H
IM.....	8	427	390	10.25:1	4 BC	MAN/AI
IP.....	8	427	425	11.0:1	4 BC	MAN/SH
IQ.....	8	427	390	10.25:1	4 BC	AUT
IR.....	8	427	390	10.25:1	4 BC	AUTO/AI

AIR - Air Injection Reactor
 HP - High Performance
 SHP - Special High Performance
 PS - Power Steering

All engines also have the model year and production sequence number (last 6 digits) of the Vehicle Identification Number stamped on the engine.

EXAMPLE: 6100001

6..... Model Year (1966)
 100001..... Production Sequence Number

THE ENGINE CASTING NUMBER for the 327 was 3858174, and in late production 3892657. The 427 casting number was 3869942, with a few bearing casting numbers 3855961 or 3855962. The casting number is located under the master brake cylinder. An alphanumeric date code is cast on the right rear of the 327 block and on the lower middle right side of the 427 block. (See Block Casting Numbers).

1966 CORVETTE

THE TRANSMISSION NUMBER on manual and Powerglide transmissions indicates the type, month and day produced and the shift it was assembled. The code for the 3-speed is located on the rear face of the case in the upper right hand corner. The code for the 4-speed is located on the left side of the case at the rear of the cover. The Powerglide is located on the bottom center of the transmission oil pan.

EXAMPLE: C1120N

C Cleveland Powerglide
 11 Month built (November)
 20 Day built (20th)
 D or N Shift built (D = Day, N = Night)
 (1 or 2) Shift built (D = day, N = night)
 (Transmissions built on day shift may not have a shift code)

TRANSMISSION CODES

TYPE	PLANT	CODE
Powerglide	Cleveland	C
4-Speed	Muncie	P
Powerglide	Toledo	T
3-Speed	Saginaw	S

THE REAR AXLE NUMBER identifies the gear ratio, the build month and day. The code is located on the right front side of the differential carrier.

EXAMPLE: AK0621W

AK 3.36 ratio
 06 June
 21 21st day of month
 W Warren Plant

DESCRIPTION	CODE
(3.36 ratio)	AK
Positraction (3.08 ratio)	AL
Positraction (3.36 ratio)	AM
Positraction (3.55 ratio)	AN
Positraction (3.70 ratio)	AO
Positraction (4.11 ratio)	AP
(3.08 ratio)	AR
4-Speed (3.70 ratio)	AS
Positraction (3.08 ratio) "396"	AT
Positraction (3.36 ratio) "396"	AU
Positraction (3.55 ratio) "396"	AZ
Positraction (3.70 ratio)	FA
Positraction (4.11 ratio) "396"	FB
Positraction (4.56 ratio) "396"	FC

1966 CORVETTE

PLANT CODES

PLANT	CC.
Chevrolet Gear & Axle	G
Buffalo	B
Warren	W

PROTECT-O-PLATE

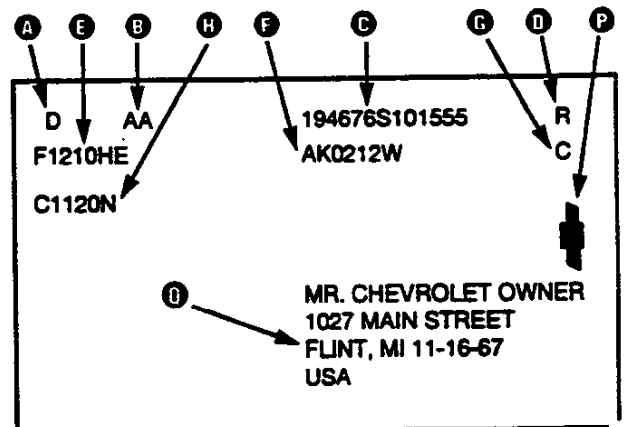

THE PROTECT-O-PLATE provides the following coded information:

DESCRIPTION	LOCATION
Interior Trim	A
Body Exterior Paint	B
Vehicle Identification Number	C
Carburetor Source Code	D
Engine Number	E
Rear Axle Number	F
Vehicle Build Month Code	G
Transmission Number	H
Chevrolet Trade Mark	P
Dealer Supplied Owner Information as Shown in Dealer Policy and Procedures Manual	Q

NOTE: The Protect-O-Plate may use the codes found on the Body Number Plate in place of the codes listed in this section, for trim and paint.

LOCATION A: Indicates the interior trim color.

COLOR	VINYL	LEATHER	CODE
Saddle	.		C
Saddle		.	J
Black	.		E
Black		.	K
Dark Green	.		X
Dark Green		.	L
Red	.		D
Red		.	M
Dark Blue	.		B
Dark Blue		.	N
Silver	.		Y
Silver		.	P
Bright Blue	.		R
Bright Blue		.	T
Blue/White	.		W

LOCATION B: Indicates the exterior paint color.

COLOR	CODE
Tuxedo Black.....	A
Ermine White.....	C
Nassau Blue.....	D
Laguna Blue.....	E
Trophy Blue.....	F
Mosport Green.....	H
Milano Maroon.....	N
Silver Pearl.....	O
Rally Red.....	R
Sunfire Yellow.....	Y

LOCATION C: Indicates the vehicle identification number. See the vehicle identification number section of this year for a complete breakdown of this number.

LOCATION D: Indicates the carburetor source/manufacturer.

TYPE	CODE
Holley.....	H
Rochester.....	R
Carter.....	C

LOCATION E: Indicates the engine number. See the engine number section of this year for a complete breakdown of this number. NOTE: The carburetor code may also appear at the end of this number.

LOCATION F: Indicates the rear axle number. See the rear axle number section of this year for a complete breakdown of this number.

LOCATION G: Indicates the month in which the vehicle was built.

MONTH	CODE
January.....	H
February.....	B
March.....	M
April.....	E
May.....	J
June.....	G
July.....	A
August.....	D
September.....	U
October.....	F
November.....	Q
December.....	C

LOCATION H: Indicates the transmission number. See the transmission number section of this year for a complete breakdown of this number.



REGULAR PRODUCTION OPTIONS (RPO)

DESCRIPTION	RPO NO.
Tinted Glass, All Windows.....	A01
Tinted Glass, Windshield.....	A02
Windows, Electric Control.....	A31
Head Rest, Conventional Type Seat.....	A82
Shoulder Harness.....	A85
Auxiliary Top Equipment.....	C07
Less Heater Equipment.....	C48
Air Conditioning, Deluxe.....	C60
Special Performance, Front & Rear Suspension.....	F41
Differential Carrier, Positraction.....	GB1
Power Brake Equipment.....	J50
Heavy Duty Brake Equipment.....	J56
Air Injection Reactor Equipment.....	K19
Transistor Ignition Equipment.....	K66
Engine, V-8 427" - Hi-Performance.....	L36
Engine, V-8 427" - Special Hi-Performance.....	L72

Engine, V-8 327" - Special Hi-Performance.....	L79
Hydraulic Lifters.....	M
4-Speed Transmission.....	M21
4-Speed Transmission, Close Ratio.....	M22
4-Speed Transmission, Heavy Duty.....	M35
Powerglide Transmission.....	N03
Gas Tank 36.5 Gallon and Filler Panel.....	N11
Off Road Service Exhaust.....	N14
Side Mount Exhausts.....	N32
Steering Wheel, Wood.....	N36
Steering Shaft, Telescopic.....	N40
Power Steering.....	P48
15x6L Aluminum Wheel, Quick Take-off.....	P92
6.70-15-4 PR Tires, Whitewall.....	T01
7.75-15-4 PR Tires, Goldwall.....	U69
Radio AM-FM, Push-button.....	V74
Hazard Warning Switch Equipment.....	Z83
Road Hazard Package.....	

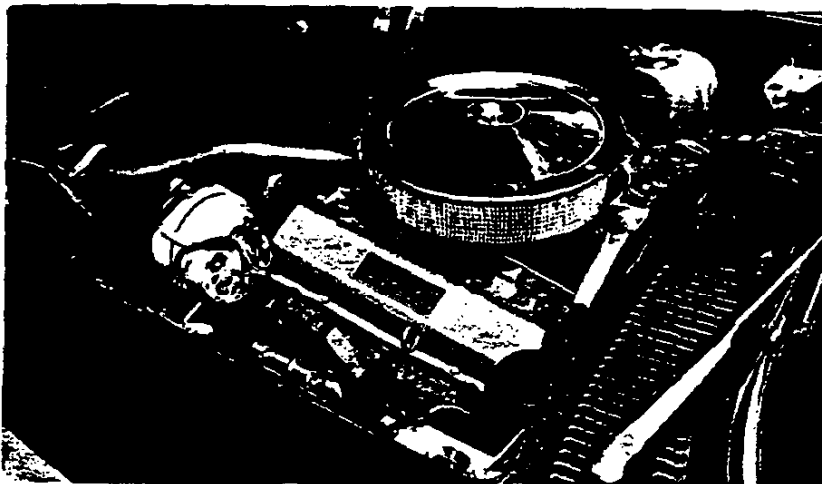
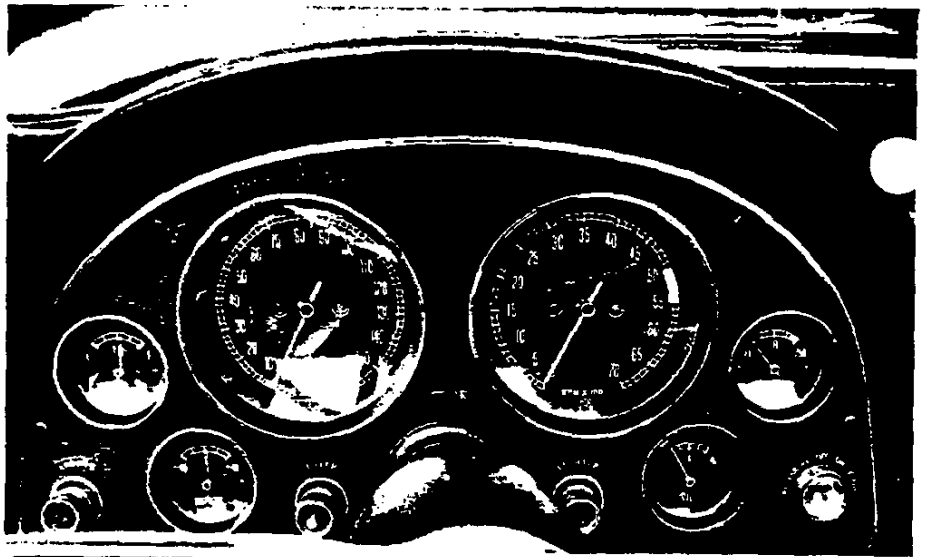



CORVETTE

1966 MODEL CORVETTE WITH STANDARD EQUIPMENT (300-hp Corvette V8 Engine—98" Wheelbase)

Model Description	List Price Less Invoice Discount (23%) [‡]	List Price Less Base Discount (25%)	Factory D & H	List Price	Mfr's Spt'd Dealer D & H	Mfr's Spt'd Retail Price [*]	Destination Charge	Total
19437 Corvette Sport Coupe 2-door—2-passenger.....						\$4295.00		
19467 Corvette Convertible—2-passenger With manually operated soft top.....						4084.00		

[‡] Base discount is 25% with the 2% difference retained for dealer's account in accordance with Terms of Sale Bulletin.

^{*} Manufacturer's Suggested Retail Price does not include state and local taxes, license fees, options or accessories.

FACTORY INSTALLED REGULAR PRODUCTION TUBELESS TIRES

Description	Option Number	Dealer Net	Factory D & H	List Price	Mfr's Suggested Retail Delivered Price [‡]
(5) 7.75-15/2-ply (4-ply rating) Regular Highway Blackwall.....	Std				N.C.
(5) 7.75-15/2-ply (4-ply rating) Regular Highway Whitewall.....	P92				31.30
(5) 7.75-15/2-ply (4-ply rating) Special Nylon Highway Goldstripe.....	T01				46.55

[‡] State and local taxes not included.

OPTIONS AND ACCESSORIES WHEN INSTALLED BY CHEVROLET

Description	Option Number	Dealer Net	Factory D & H	List Price	Mfr's Suggested Retail Delivered Price [‡]
Air Conditioning, Four-Season: With 390-hp engine and 4-speed transmission or 300-hp or 350-hp engine only. Including 61-amp Delco-tron.....	C60				\$412.90
Axle, Positraction Rear: See Power Teams chart for availability					
3.08 ratio.....	G81				42.15
3.36 ratio.....	G81				42.15
3.55 ratio.....	G81				42.15
3.70 ratio.....	G81				42.15
4.11 ratio.....	G81				42.15
Brakes, Heavy-Duty: Available only when 425-hp engine & power brakes are ordered.....	J56				342.30
Brakes, Power: Includes dual-circuit master cylinder.....	J90				42.15
Engine: For transmission availability see Power Teams chart					
350-hp Corvette 327 V8.....	L79				105.35
390-hp Corvette 427 V8—Available only when Positraction axle is ordered..	L36				181.20
425-hp Corvette 427 V8—Available only when Positraction axle and full-transistor ignition system are ordered.....	L72				312.85

[‡] State and local taxes not included.

CORVETTE

OPTIONS AND ACCESSORIES WHEN INSTALLED BY CHEVROLET (Cont'd)

Description	Option Number	Dealer Net	Factory D & H	List Price	Mr's Suggested Retail Delivered Price [◇]
Exhaust System: Off-road service —available only when 3-speed or 4-speed transmission is ordered.....	N11				\$ 36.90
Exhaust System, Dual Side Mounted: (For off-road service only).....	N14				131.65
Glass, Soft Ray Tinted: Windshield only.....	A02				10.55
All windows.....	A01				15.80
G.M. Air Injection Reactor: Approved by the state of California and exclusive to California vehicle registration only. Not required with 425-hp engine.....	K19				44.75
Harness, Shoulder: Driver and passenger.....	A85				26.35
Headrests, Strato-Ease: Driver & passenger.....	A82				42.15
Heater and Defroster Deletion: Not available when air conditioning is ordered.....	C48				97.85 CR
Ignition System, Full-Transistor: With 350-hp, 390-hp or 425-hp engines only; for detailed description see 1966 <i>Finger-Tip Facts</i> book.....	K66				73.75
Paint, Exterior: Solid colors only. See Color and Trim chart.....					N.C.
Radio, AM-FM: Pushbutton control (includes power antenna).....	U69				199.10
Special Purpose Front & Rear Suspension: Includes special springs, matching shock absorbers and special front & rear stabilizer bars (available only when 425-hp engine is ordered).....	F41				36.90
Steering, Power	N40				94.80
Steering Shaft, Telescopic	N36				42.15
Steering Wheel, Wood: (Genuine Teakwood).....	N32				47.40
Tank, Fuel: Model 19437 only (Capacity 36 gal) Also includes wheelhouse filler panel and a color-keyed fiber glass protective cover over tank in place of luggage compartment carpet.....	N03				198.05
Top, Auxiliary: Hard top; Model 19467 only.....					N.C.
In place of folding top.....	C07				231.75
In addition to folding top.....	C07				
Top, Folding: Model 19467 only. Choice of black, beige or white. All tops available with all exterior colors.....	C05				N.C.
Traffic Hazard Warning Switch	V74				11.60
Transmission: See Power Teams chart for availability					
4-Speed Manual (Wide-Range)	M20				184.35
4-Speed Manual (Close-Ratio)	M21				184.35
Powerylide	M35				194.85
Trim Combinations: See Color and Trim chart					
Genuine leather seats.....					79.00
All other trims.....					N.C.
Wheels: Five cast-aluminum 15 x 6L quick knock-off type.....	P48				316.00
Windows, Power: Electric control.....	A31				57.95

◇ State and local taxes not included.

CORVETTE POWER TEAMS

Engine, Transmission and Rear Axle Combinations

ENGINE			REAR AXLE RATIOS			
			Standard	Optional*		
Option Number	Description	TRANSMISSION	General Purpose	Mountain	Economy Cruise	Special Purpose
Standard	300-hp Corvette V8 327-cu-in displacement 4-barrel carburetor Hydraulic lifters 10.5:1 compression ratio	3-Speed 4-Speed Wide-Range	3.36:1▲		3.08:1	
		Powerglide				
L79	350-hp Corvette V8 327-cu-in displacement 4-barrel carburetor Hydraulic lifters 11.0:1 compression ratio	4-Speed Wide-Range	3.36:1▲	3.55:1		
		4-Speed Close-Ratio	3.70:1▲	4.11:1		
L36	390-hp Turbo-Jet 427 V8 427-cu-in displacement Special camshaft Hydraulic lifters 10.25:1 compression ratio	4-Speed Wide-Range	3.08:1★	3.36:1		
		4-Speed Close-Ratio Powerglide	3.36:1★	3.70:1	3.08:1	3.55:1
L72	425-hp Turbo-Jet 427 V8 427-cu-in displacement Large 4-barrel carburetor Special camshaft Mechanical lifters 11.0:1 compression ratio	4-Speed Close-Ratio	3.55:1★	3.70:1	3.36:1	4.11:1

★ Available as Positraction only (RPO G81) ▲ Also available as Positraction (RPO G81)

CORVETTE

Important Information Concerning Ordering Interior Trim and Exterior Colors

1966 CORVETTE DEALER ORDER No. 01216

DEALER NAME: **High Chevrolet, Inc.**

DEALER ADDRESS: **1000 State St. E., Grand Rapids, Mich. 49503**

DEALER PHONE: **139 6**

MODEL	EXTERIOR COLOR	EXTERIOR CODE	TRIM CODE	TRIM COLOR	TRIM CODE	TRIM COLOR	TRIM CODE	TRIM COLOR
1966 CORVETTE	Bally Red	976	Black	E	VINYL <input type="checkbox"/>	WHITE <input type="checkbox"/>	BLACK <input type="checkbox"/>	LEATHER <input type="checkbox"/>

OPTIONAL EQUIPMENT

OPTIONAL EQUIPMENT	CODE	PRICE	DESCRIPTION	PRICE
1 POWER WINDOWS	100		SPECIAL FINISH FRONT & REAR EXTERIOR	100
2 POWER SEATS	100		PALE BLUE	100
3 3 SPEED FULLY SYNCHRONIZED	100		PALE BLUE	100
4 4 SPEED - With Disc	100		PALE BLUE	100
5 4 SPEED - With Disc	100		PALE BLUE	100
6 4 SPEED - With Disc	100		PALE BLUE	100
7 4 SPEED - With Disc	100		PALE BLUE	100
8 4 SPEED - With Disc	100		PALE BLUE	100
9 4 SPEED - With Disc	100		PALE BLUE	100
10 4 SPEED - With Disc	100		PALE BLUE	100
11 4 SPEED - With Disc	100		PALE BLUE	100
12 4 SPEED - With Disc	100		PALE BLUE	100
13 4 SPEED - With Disc	100		PALE BLUE	100
14 4 SPEED - With Disc	100		PALE BLUE	100
15 4 SPEED - With Disc	100		PALE BLUE	100
16 4 SPEED - With Disc	100		PALE BLUE	100
17 4 SPEED - With Disc	100		PALE BLUE	100
18 4 SPEED - With Disc	100		PALE BLUE	100
19 4 SPEED - With Disc	100		PALE BLUE	100
20 4 SPEED - With Disc	100		PALE BLUE	100
21 4 SPEED - With Disc	100		PALE BLUE	100
22 4 SPEED - With Disc	100		PALE BLUE	100
23 4 SPEED - With Disc	100		PALE BLUE	100
24 4 SPEED - With Disc	100		PALE BLUE	100
25 4 SPEED - With Disc	100		PALE BLUE	100
26 4 SPEED - With Disc	100		PALE BLUE	100
27 4 SPEED - With Disc	100		PALE BLUE	100
28 4 SPEED - With Disc	100		PALE BLUE	100
29 4 SPEED - With Disc	100		PALE BLUE	100
30 4 SPEED - With Disc	100		PALE BLUE	100
31 4 SPEED - With Disc	100		PALE BLUE	100
32 4 SPEED - With Disc	100		PALE BLUE	100
33 4 SPEED - With Disc	100		PALE BLUE	100
34 4 SPEED - With Disc	100		PALE BLUE	100
35 4 SPEED - With Disc	100		PALE BLUE	100
36 4 SPEED - With Disc	100		PALE BLUE	100
37 4 SPEED - With Disc	100		PALE BLUE	100
38 4 SPEED - With Disc	100		PALE BLUE	100
39 4 SPEED - With Disc	100		PALE BLUE	100
40 4 SPEED - With Disc	100		PALE BLUE	100
41 4 SPEED - With Disc	100		PALE BLUE	100
42 4 SPEED - With Disc	100		PALE BLUE	100
43 4 SPEED - With Disc	100		PALE BLUE	100
44 4 SPEED - With Disc	100		PALE BLUE	100
45 4 SPEED - With Disc	100		PALE BLUE	100
46 4 SPEED - With Disc	100		PALE BLUE	100
47 4 SPEED - With Disc	100		PALE BLUE	100
48 4 SPEED - With Disc	100		PALE BLUE	100
49 4 SPEED - With Disc	100		PALE BLUE	100
50 4 SPEED - With Disc	100		PALE BLUE	100
51 4 SPEED - With Disc	100		PALE BLUE	100
52 4 SPEED - With Disc	100		PALE BLUE	100
53 4 SPEED - With Disc	100		PALE BLUE	100
54 4 SPEED - With Disc	100		PALE BLUE	100
55 4 SPEED - With Disc	100		PALE BLUE	100
56 4 SPEED - With Disc	100		PALE BLUE	100
57 4 SPEED - With Disc	100		PALE BLUE	100
58 4 SPEED - With Disc	100		PALE BLUE	100
59 4 SPEED - With Disc	100		PALE BLUE	100
60 4 SPEED - With Disc	100		PALE BLUE	100
61 4 SPEED - With Disc	100		PALE BLUE	100
62 4 SPEED - With Disc	100		PALE BLUE	100
63 4 SPEED - With Disc	100		PALE BLUE	100
64 4 SPEED - With Disc	100		PALE BLUE	100
65 4 SPEED - With Disc	100		PALE BLUE	100
66 4 SPEED - With Disc	100		PALE BLUE	100
67 4 SPEED - With Disc	100		PALE BLUE	100
68 4 SPEED - With Disc	100		PALE BLUE	100
69 4 SPEED - With Disc	100		PALE BLUE	100
70 4 SPEED - With Disc	100		PALE BLUE	100
71 4 SPEED - With Disc	100		PALE BLUE	100
72 4 SPEED - With Disc	100		PALE BLUE	100
73 4 SPEED - With Disc	100		PALE BLUE	100
74 4 SPEED - With Disc	100		PALE BLUE	100
75 4 SPEED - With Disc	100		PALE BLUE	100
76 4 SPEED - With Disc	100		PALE BLUE	100
77 4 SPEED - With Disc	100		PALE BLUE	100
78 4 SPEED - With Disc	100		PALE BLUE	100
79 4 SPEED - With Disc	100		PALE BLUE	100
80 4 SPEED - With Disc	100		PALE BLUE	100
81 4 SPEED - With Disc	100		PALE BLUE	100
82 4 SPEED - With Disc	100		PALE BLUE	100
83 4 SPEED - With Disc	100		PALE BLUE	100
84 4 SPEED - With Disc	100		PALE BLUE	100
85 4 SPEED - With Disc	100		PALE BLUE	100
86 4 SPEED - With Disc	100		PALE BLUE	100
87 4 SPEED - With Disc	100		PALE BLUE	100
88 4 SPEED - With Disc	100		PALE BLUE	100
89 4 SPEED - With Disc	100		PALE BLUE	100
90 4 SPEED - With Disc	100		PALE BLUE	100
91 4 SPEED - With Disc	100		PALE BLUE	100
92 4 SPEED - With Disc	100		PALE BLUE	100
93 4 SPEED - With Disc	100		PALE BLUE	100
94 4 SPEED - With Disc	100		PALE BLUE	100
95 4 SPEED - With Disc	100		PALE BLUE	100
96 4 SPEED - With Disc	100		PALE BLUE	100
97 4 SPEED - With Disc	100		PALE BLUE	100
98 4 SPEED - With Disc	100		PALE BLUE	100
99 4 SPEED - With Disc	100		PALE BLUE	100
100 4 SPEED - With Disc	100		PALE BLUE	100

MODEL	EXTERIOR COLOR	EXTERIOR CODE	TRIM CODE	TRIM COLOR	TRIM CODE	TRIM COLOR	TRIM CODE	TRIM COLOR
1966 CORVETTE	Bally Red	976	Black	E	VINYL <input type="checkbox"/>	WHITE <input type="checkbox"/>	BLACK <input type="checkbox"/>	LEATHER <input type="checkbox"/>

Explanation of Exterior Color Identification All exterior paints will be identified by a 3-digit number as indicated on the Color & Trim chart. Two-tone exteriors are not available on Corvettes.

Explanation of Interior Trim Identification Ordering codes remain single alphabetical letters (SEE CHART ON OPPOSITE PAGE). Trim option numbers are for invoicing only to denote color of trim.

PLEASE GIVE SPECIAL ATTENTION TO THE FOLLOWING

SERIES	REMARKS
CORVETTE STING RAY	Green or White/Blue interior trim available in vinyl only. White/Blue trim: Instrument panel and carpet are medium blue. Silver trim: Instrument panel is black and carpet is dark gray. Convertible Top: Black, Beige or White. Each is available with all exterior colors. Extra cost optional leather interior—seats only are genuine leather.

CORVETTE COLOR & TRIM CHART

INTERIOR TRIM CODES			EXTERIOR COLORS																																				
<p>The following code must be shown on the order form for the desired interior trim.</p> <table style="width: 100%; border: none;"> <tr> <td style="width: 30%;">LEATHER</td> <td style="width: 30%;">VINYL</td> <td></td> </tr> <tr> <td>K - BLACK</td> <td>- E</td> <td></td> </tr> <tr> <td>J - SADDLE</td> <td>- C</td> <td></td> </tr> <tr> <td>M - RED</td> <td>- D</td> <td></td> </tr> <tr> <td>N - DARK BLUE</td> <td>- B</td> <td></td> </tr> <tr> <td>P - SILVER</td> <td>- Y</td> <td></td> </tr> <tr> <td></td> <td>- X</td> <td></td> </tr> <tr> <td>T - BRIGHT BLUE</td> <td>- R</td> <td></td> </tr> <tr> <td></td> <td>- W</td> <td></td> </tr> </table>			LEATHER	VINYL		K - BLACK	- E		J - SADDLE	- C		M - RED	- D		N - DARK BLUE	- B		P - SILVER	- Y			- X		T - BRIGHT BLUE	- R			- W		Tuxedo Black	Ermine White	Rally Red	Nassau Blue	Laguna Blue	Trophy Blue	Mosport Green	Sunfire Yellow	Silver Pearl	Milano Maroon
LEATHER	VINYL																																						
K - BLACK	- E																																						
J - SADDLE	- C																																						
M - RED	- D																																						
N - DARK BLUE	- B																																						
P - SILVER	- Y																																						
	- X																																						
T - BRIGHT BLUE	- R																																						
	- W																																						
MODELS	Exterior Paint Int. Trim & RPO		RPO	900	972	974	976	978	980	982	984	986	988																										
CONVERTIBLE 19467 SPORT COUPE 19437	S T A N D A R D V I N Y L	Black	Std	E	E	E	E	E	E	E	E	E	E																										
		Red	407	D	D	D																																	
		Bright Blue	414	R	R			R	R																														
		Dark Blue	418	B	B			B	B	B																													
		Saddle	420	C	C									C																									
		Silver	426	Y	Y								Y																										
		Green	430	X	X						X																												
		White/Br. Blue	450	W	W			W																															
CONVERTIBLE 19467 SPORT COUPE 19437	O P T I O N A L L E A T H E R	Black	402	K	K	K	K	K	K	K	K	K	K																										
		Red	408	M	M	M																																	
		Bright Blue	415	T	T			T	T																														
		Dark Blue	419	N	N			N	N	N																													
		Saddle	421	J	J									J																									
		Silver	427	P	P								P																										



1966 CORVETTE STING RAY

INDEX TO MODEL INFORMATION

MODELS & IDENTIFICATION	2
FEATURES & APPOINTMENTS	3
SPECIFICATIONS	3
POWER TRAINS	4-9
BODY FEATURES	10-11
CHASSIS SPECIFICATIONS	12-13
OPTIONS & ACCESSORIES	14

CORVETTE STING RAY

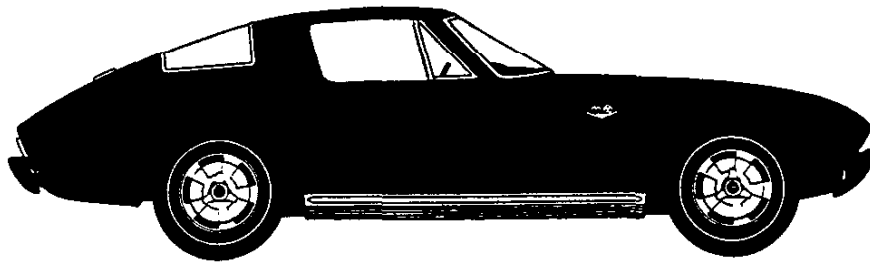

Corvette Sting Ray Sport Coupe

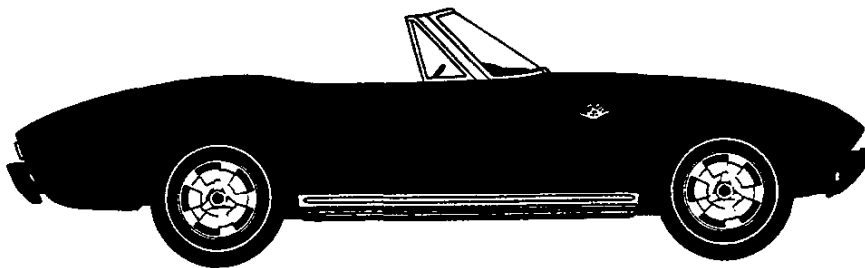
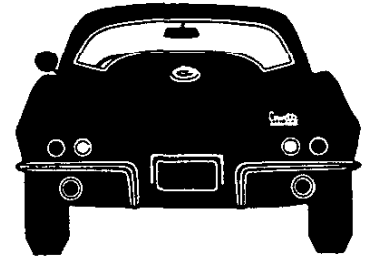

Corvette Sting Ray Convertible

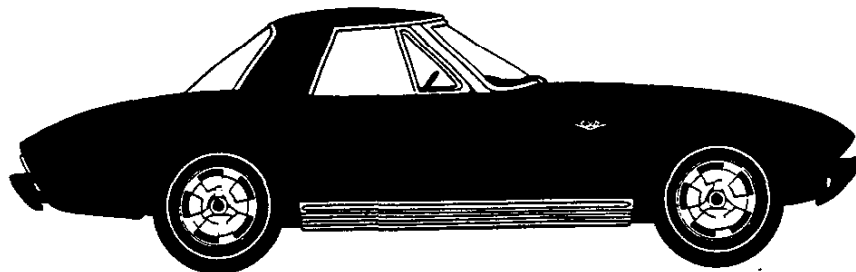
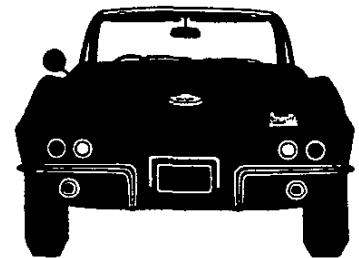

Corvette Sting Ray Convertible with removable hardtop*

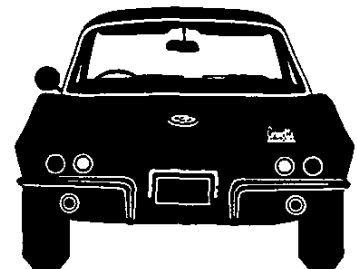

■ Sport Coupe ■ Convertible

Model Features

Black-accented body sill moldings • Windshield and rear window reveal moldings (windshield only with Convertible folding top) • Bright ventipane frames • Bright windshield pillar on Convertible • Wrap-around bumpers • Ventilated wheel covers with simulated 3-lug knock-off hub • Front fender emblems • Front fender engine compartment air exhaust louvers • Chromed outside rearview mirror • Anodized aluminum grille • Circular parking and directional signal lights with bright bezels • Bright front

license plate frame • Hood emblem • Power-operated retractable dual headlights • Special high-domed hood with 427-cu.-in. V8's • Fuel filler door emblem • Sting Ray nameplate • Bright rear license plate frame and license plate recess framing • Twin-unit taillights with bright bezels and built-in back-up lights • Twin stainless steel tailpipes with bright bezels • Luxurious all-vinyl trim . . . plus Corvette interior features and appointments.

**Optional at no extra cost in place of convertible folding top or in addition at extra cost*

INTERIOR FEATURES & APPOINTMENTS

	Sport Coupe	Convertible
INSTRUMENT PANEL		
Special sports-styled three-spoke steering wheel with horn button	•	•
Foam-padded instrument cluster and glove compartment hoods	•	•
Black textured-finish instrument cluster and glove compartment hood facing	•	•
Instrument cluster and glove compartment hood trim moldings	•	•
Brushed chrome glove compartment door trim panel with bright outline molding and nameplate	•	•
Built-in passenger assist grip	•	•
Bright control knobs	•	•
Black painted instrument bezels with bright facing	•	•
Tachometer, speedometer with odometer, plus separate trip odometer	•	•
Ammeter, oil pressure, fuel and temperature gauges	•	•
Cigarette lighter	•	•
Bright parking brake handle	•	•
Parking brake warning light	•	•
Glove compartment lock and light	•	•
Center console with electric clock and heater controls (also optional radio controls)	•	•
Power-operated retractable headlight warning light	•	•
DOORS & SIDE PANELS		
Textured vinyl-finish molded door trim panels with bright accents	•	•
Combination textured vinyl and carpet rear compartment sidewall and wheelhouse trim	•	•
Carpeted cowl side panels	•	•
Bright ball-type door opening knobs	•	•
Crank-operated ventipanes	•	•
Molded-in door armrests and bright door pull handles	•	•
SEATS		
All-vinyl seat trim (genuine leather seat trim optional at extra cost)	•	•
Foam-cushioned bucket seats with formed seat back panel and bright seat back outline moldings	•	•
Deluxe color-matched seat belts with retractors	•	•
HEADLINING, FLOOR COVERING & INTERIOR FEATURES		
Vinyl-covered foam headlining	•	•
Vinyl-covered padded sun visors	•	•
Color-keyed deep-twist floor and luggage compartment carpeting	•	•
Chrome-backed rearview mirror	•	•
Color-keyed painted windshield, door, and rear window garnish moldings	•	•
Bright windshield header	•	•
LIGHTS, SWITCHES & POWER EQUIPMENT		
Instrument panel interior light switch (in headlight switch)	•	•
Center dome light with automatic door switches	•	•
Dual instrument panel courtesy lights with automatic door switches	•	•
Power windows	EC	EC
Power-operated retractable headlight instrument panel switch	•	•

EC—Extra cost.

SPECIFICATIONS

	Sport Coupe	Convertible
EXTERIOR DIMENSIONS		
Wheelbase	98.0	
Length (overall)	175.1	
Width (overall)	69.6	
Height (loaded)	49.6	49.8
Front tread	56.8	
Rear tread	57.6	
Road clearance (min.)	5.0	
INTERIOR ROOMINESS		
Torso room	37.0	38.5
Leg room	42.7	
Hip room	50.9	
Shoulder room	48.4	
Entrance height	31.4	30.2
LUGGAGE COMPARTMENT		
Total volume (cu. ft.)	19.1	15.3
Usable luggage space (cu. ft.)	10.6	8.1

	Sport Coupe	Convertible
GLASS AREA		
Windshield glass area (sq. in.)	789.7	
Rear window glass area (sq. in.)	821.5	440.5
Total glass area (sq. in.)	2231.3	1780.3
TIRE SIZE & STEERING SPECIFICATIONS*		
Standard tire size	7.75 x 15	
Turning diameter—curb-to-curb (ft.)	39.9	
Turning diameter—wall-to-wall (ft.)	41.6	
Steering ratio—standard (overall)	20.2:1	
Steering ratio—special fast ratio (overall)	17.6:1	
Steering ratio—power (overall)	17.6:1	
FUEL CAPACITY & WEIGHT		
Fuel tank capacity (gallons)	20	
Curb weight—standard V8 (lbs.)	3145	3160
Shipping weight—standard V8 (lbs.)	2985	3005

*For additional information, see Tires in Feature Details section.

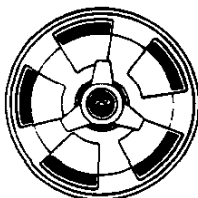

Mag-style wheel covers—standard on all Corvettes

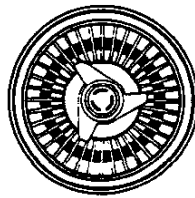

Special cast aluminum wheels with 6" rims—optional for all Corvettes



Corvette 327-cu.-in. V8 front fender emblem



Corvette 427-cu.-in. V8 front fender emblem

1966 CORVETTE POWER TEAMS

ENGINES
TRANSMISSIONS
AXLE RATIOS

ENGINE	3-SPEED FULLY SYNCH. 2.54:1 LOW STANDARD	4-SPEED FULLY SYNCH. 2.52:1 LOW RPO M20	4-SPEED FULLY SYNCH. 2.20:1 LOW RPO M21	**SPECIAL 4-SPEED FULLY SYNCH. 2.20:1 LOW RPO M22	POWERGLIDE RPO M35
STANDARD ENGINE 300-HP CORVETTE V8 (327-CU.-IN.)	STD.—3.36:1 (a) *OPT.—3.08:1 (b)	STD.—3.36:1 (a) *OPT.—3.08:1 (b)			STD.—3.36:1 (a)
RPO L79 350-HP CORVETTE V8 (327-CU.-IN.)		STD.—3.36:1 (a) *OPT.—3.55:1 (c)	STD.—3.70:1 (a) *OPT.—4.11:1 (c)		
RPO L36 390-HP TURBO-JET V8 (427-CU.-IN.)		*STD.—3.08:1 (a) *OPT.—3.36:1 (c)	*STD.—3.36:1 (a) *OPT.—3.08:1 (b) *OPT.—3.70:1 (c) *OPT.—3.55:1 (d)		
RPO L72 425-HP TURBO-JET V8 (427-CU.-IN.)			*STD.—3.55:1 (a) *OPT.—3.36:1 (b) *OPT.—3.70:1 (c) *OPT.—4.11:1 (d)	*OPT.—3.08:1 (e) *OPT.—3.36:1 (e) *OPT.—3.55:1 (e) *OPT.—3.70:1 (e) *OPT.—4.11:1 (e) *OPT.—4.56:1 (e)	
Note: Positraction rear axle available in all standard ratios. * Available in Positraction axle only. **Not recommended for general use.		(a) General purpose axle (b) Economy cruise axle (c) Mountain axle (d) Special purpose axle (e) Purchaser to specify axle choice			

CLUTCHES for Corvette 3- and 4-Speed Transmission Power Teams

Specifications	327-cu.-in. V8's	427-cu.-in. V8's
Type	Semi-centrifugal diaphragm spring with single dry disc—pearlitic or nodular iron pressure plate	
Spring Effective Plate Load—lbs.	2100-2300	2300-2600
Disc Facing Material	Woven asbestos—Premium grade	
Disc Facing Outside Diameter (inches)	10.0	10.5
Disc Facing Total Area (square inches)	90.7	103.5

Corvette clutches are single dry disc design with a light alloy aluminum housing, and feature centrifugally assisted diaphragm spring engagement, special high-load pressure plate, plus premium-quality woven asbestos disc facings. Clutch disc sizes and spring pressures are matched to each engine (see chart) for smooth shifting and long life.

REAR AXLE DETAILS

Semi-floating hypoid gear rear axle with frame-mounted welded steel housing and double universal jointed tubular axle shafts. Lubricant capacity—3.7 pints. General Purpose axle ratios offer best balance of performance and economy with each power team. For special requirements, other axle ratios are optional with many power teams . . . see Power Teams chart. Extra-cost Positraction rear axle (RPO G81) available for all standard ratios; optional ratios available only as Positraction.

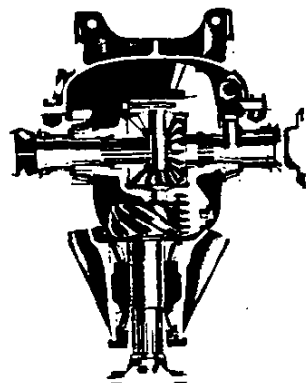

Transmissions

3-SPEED FULLY SYNCHRONIZED — Standard with 300-hp engine only. Manually operated 3-speed transmission with full synchronization of all forward gears for smooth shifting when downshifting or accelerating. Basically similar in design and construction to regular Chevrolet 3-speed transmission, with special heavy-duty, extra-durable clutch drive gear and mainshaft bearings for higher torque loadings. Floor-mounted shift lever in center console.

Ratios	300-hp 327 cu.-in. V8
First	2.54:1
Second	1.50:1
Third	1.00:1
Reverse	2.63:1

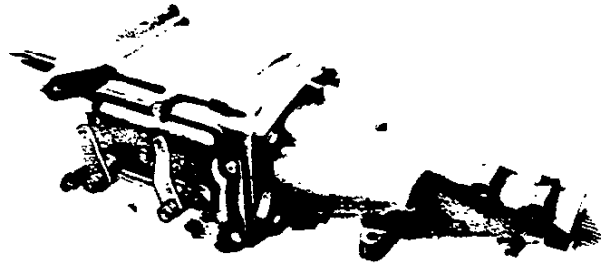

4-SPEED FULLY SYNCHRONIZED—RPO M20, M21 AND M22—Manually operated 4-speed transmissions with full synchronization of all forward gears for smooth shifting when downshifting or accelerating. Special ratio (2.52:1 low) 4-speed, RPO M20 optional with 300-, 350-, and 390-hp V8's. Close-ratio (2.20:1 low) 4-speed, RPO M21, available with 350-, 390- and 425-hp engines. Special close-ratio (RPO M22) available for 425-hp engine but is not recommended for general use. Floor-mounted shift lever in center console.

Ratios	RPO M20 300-, 350- and 390-hp V8's	RPO M21 350-, 390- and 425-hp V8's	RPO M22 425-hp V8
First	2.52:1	2.20:1	2.20:1
Second	1.88:1	1.64:1	1.64:1
Third	1.47:1	1.27:1	1.27:1
Fourth	1.00:1	1.00:1	1.00:1
Reverse	2.59:1	2.26:1	2.26:1

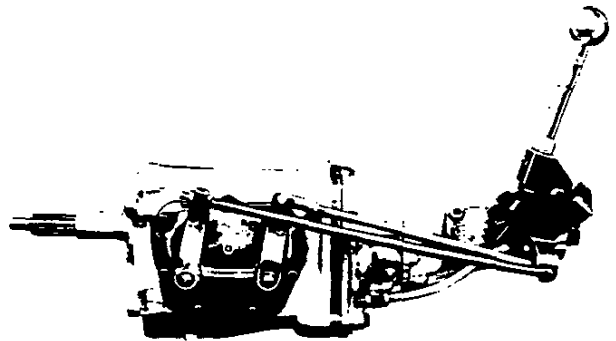

POWERGLIDE—RPO M35—Three-element torque converter automatic transmission with 2-speed planetary gearset. Basically similar in design and construction to regular Chevrolet Powerglide. Not offered with 350-, 390- and 425-hp engines. Floor-mounted selector lever in center console. Accelerator-actuated automatic downshift into low gear for extra passing power.

Torque Multiplication	300-hp Corvette V8
Drive (maximum)	3.70:1 to 1:1 range
Low and reverse	3.70:1 to 1.76:1 range

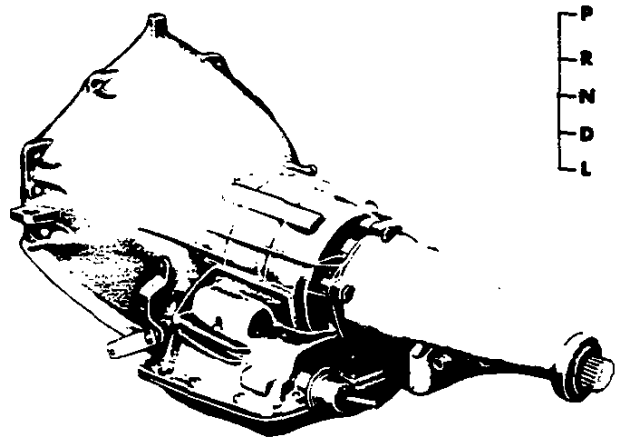

300-hp Corvette V8 (STANDARD V8)



ENGINE TYPE	V8—VALVE-IN-HEAD
DISPLACEMENT	327 CU. IN.
BORE & STROKE	4.0" x 3.25"
HP @ RPM	300 @ 5000
TORQUE @ RPM (ft.-lbs.)	360 @ 3200
COMPRESSION RATIO	10.5:1
CARBURETION	4-BARREL AUTOMATIC CHOKE
FUEL REQUIREMENT	PREMIUM
CAMSHAFT TYPE	GENERAL PERFORMANCE
VALVE LIFTERS	HYDRAULIC
EXHAUST SYSTEM	DUAL

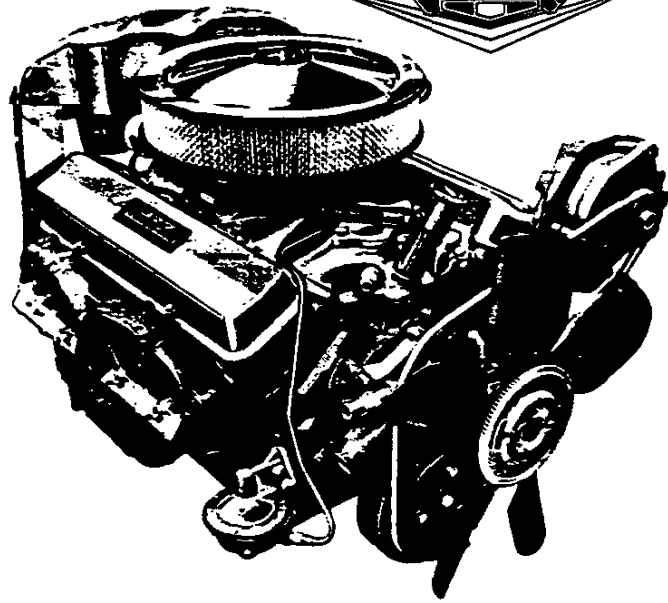

BASIC DESIGN Cast alloy iron block and cylinder heads with precision-cast wedge-type combustion chambers. Three-ring aluminum alloy pistons with offset piston pins and special steel struts to control expansion. Chrome-plated top ring, wear-resistant coated second ring with steel expander, three-piece oil control ring (two rails and one spacer-expander) with chromed rails. Forged steel connecting rods with piston pins clamped in upper end and replaceable lower bearings. Rugged forged alloy steel crankshaft with five replaceable main bearings. Premium quality aluminum main and connecting rod bearing inserts. Flywheel: machined cast alloy iron with manual transmissions, pressed steel with Powerglide. Power plant mounted on rubber cushions, two front, one rear.

FUEL AND INDUCTION SYSTEM Four-barrel carburetor with automatic choke and oil-wetted paper element air cleaner. Cast alloy iron 8-port double-deck intake manifold. Mechanical pulsator-type fuel pump driven by camshaft. Sintered bronze fuel filter in carburetor, fine-mesh fuel strainer in fuel tank. Electric fuel gauge. Fuel tank capacity 20 gallons. Recommended fuel: premium.

VALVE SYSTEM Valve-in-head, with independent operating mechanism for each valve. Formed steel valve rocker covers. Valve material: intake, alloy steel; exhaust, high alloy steel with aluminized face. Integral valve guides and seats machined in cylinder heads. Variable-pitch valve springs. Pressed steel rocker arms with ball and socket mounting. Tubular steel push rods actuated by quiet hydraulic valve lifters. Cast alloy iron camshaft with wear-resistant coating, mounted in five steel-backed babbitt bearings and driven from crankshaft by silent chain.

EXHAUST SYSTEM Dual 2.5" system (2.0" with Powerglide) with oval reverse-flow mufflers. Precision-cast alloy iron exhaust manifolds of ram's horn design with balance pipe. Rolled lock seam muffler construction. Left side muffler: Asbestos-wrapped aluminized body and aluminized cover with heads and all interior parts completely aluminized on both sides. Right side muffler: Asbestos-wrapped stainless steel body with aluminized cover; stainless steel heads, front and rear outer baffles, and rear tube; all other interior parts completely aluminized. Stainless steel tailpipes.

ELECTRICAL SYSTEM 12-volt, with 61-ampere-hour battery and 9-37-ampere Delcotron diode-rectifying type generator protected by voltage regulator. Distributor: single-breaker, vacuum-centrifugal advance. Positive shift high-torque starter with solenoid-engaged drive pinion and overrunning clutch. Hermetically sealed ignition coil. Non-metallic high-tension spark cables with rubber spark plug boots. Spark plugs: AC 44. Positive tachometer drive from distributor shaft.

COOLING SYSTEM Pressurized liquid type with full-length water jackets completely surrounding cylinder barrels. Centrifugal water pump with sealed double-row bearing, capacity 57 gallons per minute at 4400 engine rpm. Aluminum cross-flow radiator, 315.4-sq.-in. frontal area. 15-lb. pressure cap and pellet-type thermostat for quick engine warm-up. Five-blade temperature-controlled viscous drive fan, 17.1" diameter with circular shroud. Single-belt water pump and fan drive.

LUBRICATION SYSTEM Controlled full-pressure type with full-flow replaceable element type oil filter. Refill capacity four quarts (five with filter replacement). Gear-type oil pump with fixed intake develops normal 40 p.s.i. oil pressure at 2000 engine rpm. Positive-type crankcase ventilation standard.

150-hp Corvette V8 (RPO L79)



ENGINE TYPE	V8—VALVE-IN-HEAD
DISPLACEMENT	327 CU. IN.
BORE & STROKE	4.0" x 3.25"
HP @ RPM	350 @ 5800
TORQUE @ RPM (ft.-lbs.)	360 @ 3600
COMPRESSION RATIO	11.0:1
CARBURETION	4-BARREL AUTOMATIC CHOKE
FUEL REQUIREMENT	SPECIAL PREMIUM
CAMSHAFT TYPE	HIGH PERFORMANCE
VALVE LIFTERS	HYDRAULIC
EXHAUST SYSTEM	DUAL

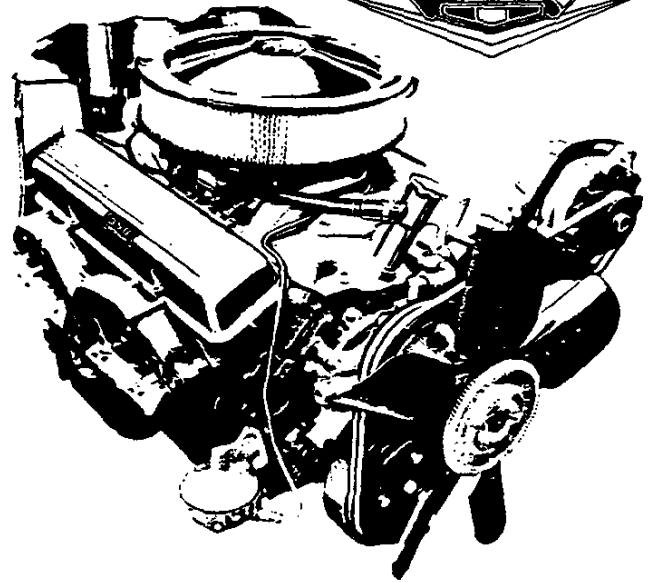

BASIC DESIGN Cast alloy iron block and cylinder heads with precision-cast wedge-type combustion chambers. Three-ring impact-extruded domed aluminum alloy pistons with special steel struts to control expansion. Molybdenum-inlay top ring, chrome plated second ring and three-piece oil control ring (two rails and one spacer-expander) with chromed rails. Forged steel connecting rods with piston pins clamped in upper end and replaceable lower bearings. Rugged forged alloy steel crankshaft with five replaceable main bearings. Premium quality aluminum main and connecting rod bearing inserts. Flywheel: machined cast alloy iron with manual transmissions, pressed steel with Powerglide. Power plant mounted on rubber cushions, two front, one rear.

FUEL AND INDUCTION SYSTEM Four-barrel carburetor with automatic choke and oil-wetted paper element air cleaner. Extra-large 8-port double-deck aluminum intake manifold. Mechanical pulsator-type fuel pump driven by camshaft. Sintered bronze fuel filter in carburetor, fine-mesh strainer in fuel tank. Electric fuel gauge. Fuel capacity 20 gallons. Recommended fuel: special premium.

VALVE SYSTEM Valve-in-head, with independent operating mechanism for each valve. Finned aluminum valve rocker covers. Valve material: intake, alloy steel; exhaust, high alloy steel with aluminized head and face. Integral valve guides and seats machined in cylinder heads. Variable-pitch valve springs. Pressed steel rocker arms with ball and socket mounting. Tubular steel push rods actuated by quiet hydraulic lifters. Cast alloy iron camshaft with wear-resistant coating, mounted in five steel-backed babbitt bearings and chain-driven from crankshaft.

EXHAUST SYSTEM Dual 2.5" system with oval reverse-flow mufflers. Precision cast alloy iron exhaust manifolds of ram's horn design with balance pipe. Rolled lock seam muffler construction. Left side muffler: asbestos-wrapped aluminized body and aluminized cover with heads and all interior parts completely aluminized on both sides for extended durability. Right side muffler: asbestos-wrapped stainless steel body with aluminized cover; stainless steel heads, front and rear outer baffles, and rear tube; all other parts completely aluminized.

ELECTRICAL SYSTEM 12-volt with 61-ampere-hour battery and 9-37-ampere Delcotron diode-rectifying type generator protected by voltage regulator. Distributor: single-breaker, vacuum-centrifugal advance. Positive-shift high-torque starter with solenoid-engaged drive pinion and overrunning clutch. Hermetically sealed ignition coil. Non-metallic high-tension spark cables with rubber spark plug boots. Spark plugs: AC 44. Positive tachometer drive from distributor shaft. Delcotronic full-transistor ignition system optional at extra cost (RPO K66).

COOLING SYSTEM Pressurized liquid type with full-length water jackets completely surrounding cylinder barrels. Centrifugal water pump with sealed double-row bearing, capacity 57 gallons per minute at 4400 engine rpm. Aluminum cross-flow radiator, 315.4-sq.-in. frontal area. 15-lb. pressure cap and pellet-type thermostat for quick engine warm-up. Five-blade temperature-controlled viscous drive fan, 17.1" diameter with circular shroud. Double-belt water pump and fan drive.

LUBRICATION SYSTEM Controlled full-pressure type with full-flow replaceable element type oil filter. Refill capacity five quarts (six with filter replacement). Gear-type oil pump with fixed intake develops normal 40 p.s.i. oil pressure at 2000 engine rpm. Positive-type crankcase ventilation standard.

390-hp Turbo-Jet 427 (RPO L36)

ENGINE TYPE	V8—VALVE-IN-HEAD
DISPLACEMENT	427 CU. IN.
BORE & STROKE	4.25" x 3.76"
HP @ RPM	390 @ 5200
TORQUE @ RPM (ft.-lbs.)	460 @ 3600
COMPRESSION RATIO	10.25:1
CARBURETION	4-BARREL AUTOMATIC CHOKE
FUEL REQUIREMENT	PREMIUM OR SPECIAL PREMIUM
CAMSHAFT TYPE	HIGH PERFORMANCE
VALVE LIFTERS	HYDRAULIC
EXHAUST SYSTEM	DUAL

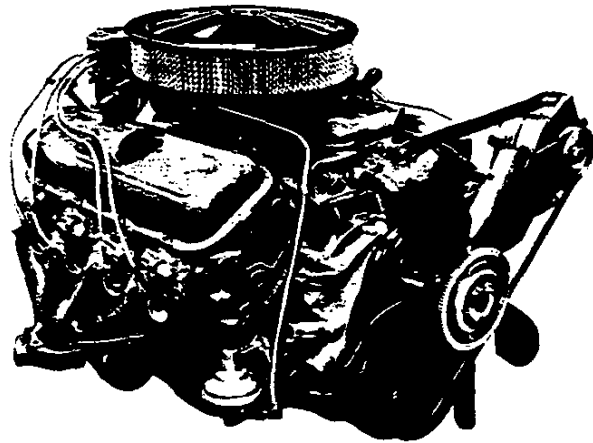

BASIC DESIGN Cast alloy iron block with extra-thick bulkheads above each bearing support for greater strength and more rigid crankshaft support. Cylinder heads cast of alloy iron with alternately spaced inlet and exhaust valve ports and precision-formed modified-wedge combustion chambers. Three-ring precision-cast aluminum alloy pistons with centered chromium steel piston pins. Molybdenum-inlay top ring, wear-resistant coated second ring and three-piece oil control ring (two rails and one spacer-expander) with chromed rails. Forged high-alloy steel connecting rods with piston pins clamped in upper end and replaceable lower bearings. Forged alloy steel crankshaft with replaceable main bearings and special wide-base main bearing caps for firmer clamping. Premium aluminum main and connecting rod bearings. Machined cast alloy iron flywheel. Power plant mounted on rubber cushions, two front, one rear.

FUEL AND INDUCTION SYSTEM Four-barrel carburetor with automatic choke and oil-wetted paper-element air cleaner. Precision-cast alloy aluminum 8-port intake manifold with extra-large ports. Mechanical pulsator-type sealed fuel pump driven by camshaft. Paper element type fuel filter between carburetor and fuel pump. Fine-mesh strainer in tank. Electric fuel gauge. Fuel tank capacity 20 gallons. Recommended fuel: premium or special premium.

VALVE SYSTEM Valve-in-head, with independent operating mechanism for each valve. Formed steel rocker covers. Valve material: intake, alloy steel with aluminized face and head; exhaust, heat-treated high-alloy steel with aluminized face and head. Pressed-in valve guides; valve seats machined in cylinder heads. Variable-pitch valve springs. Pressed steel rocker arms with ball and socket mountings. Tubular steel push rods with hardened steel ball tips actuated by quiet hydraulic valve lifters. High performance cast alloy iron camshaft with wear-resistant coating, mounted in five steel-backed babbitt bearings and driven from crankshaft by silent chain.

EXHAUST SYSTEM Dual 2.5" system with oval reverse-flow mufflers. Precision-cast large free-flow alloy iron exhaust manifolds. Rolled lock seam muffler construction. Right side muffler: stainless steel heads, baffles 1-4 and outlet pipe, and asbestos-wrapped stainless steel body with aluminized cover. Left side muffler: aluminized heads and asbestos-wrapped aluminized body with aluminized interior and cover.

ELECTRICAL SYSTEM 12-volt, 61-ampere-hour battery and 9-37-ampere Delcotron diode-rectifying generator protected by voltage regulator. Positive-shift high-torque starter with solenoid-engaged drive pinion and overrunning clutch. Hermetically sealed ignition coil. Single-breaker distributor with combination centrifugal and vacuum spark advance. Non-metallic high-tension spark cables. Spark plugs: AC 43N normal service type with rubber boots. Delcotronic full-transistor ignition system optional at extra cost (RPO K66).

COOLING SYSTEM Pressurized liquid type with full-length water jackets completely surrounding cylinder barrels. Centrifugal high-capacity water pump with sealed double-row bearing, capacity 82 gallons per minute at 5200 engine rpm. Cross-flow radiator, 382 sq.-in. frontal area. 15-lb. pressure cap and pellet-type thermostat for quick warm-up. Five-blade temperature-controlled viscous drive fan, 17.1" diameter with circular shroud. Double-belt water pump and fan drive.

LUBRICATION SYSTEM Controlled full-pressure type with high-output oil pump and full-flow replaceable element oil filter. Refill capacity five quarts (six with filter replacement). Gear-type oil pump with fixed intake develops normal 50-75 p.s.i. oil pressure at 2000 engine rpm. Positive-type crankcase ventilation standard, closed positive-type ventilation optional at extra cost (RPO K24).

25-HP Turbo-Jet (RPO L72)

ENGINE TYPE	V8—VALVE-IN-HEAD
DISPLACEMENT	427 CU. IN.
BORE & STROKE	4.25" x 3.76"
HP @ RPM	425 @ 5600
TORQUE @ RPM (ft.-lbs.)	460 @ 4000
COMPRESSION RATIO	11.0:1
CARBURETION	LARGE 4-BARREL AUTOMATIC CHOKE
FUEL REQUIREMENT	SPECIAL PREMIUM
CAMSHAFT TYPE	SPECIAL PERFORMANCE
VALVE LIFTERS	MECHANICAL
EXHAUST SYSTEM	DUAL

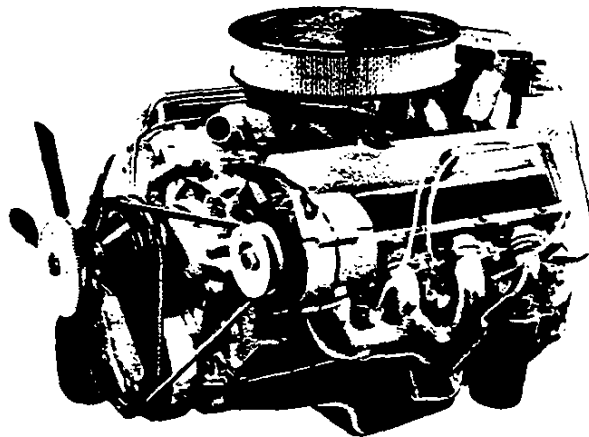

BASIC DESIGN Cast alloy iron block with extra-thick bulkheads above each bearing support for greater strength and more rigid crankshaft support. Cylinder heads cast of alloy iron with alternately spaced inlet and exhaust valve ports and precision-formed modified-wedge combustion chambers. Special high-strength three-ring impact-extruded domed aluminum alloy pistons with centered chromium steel piston pins. Molybdenum-inlay top ring, chrome plated second ring and three-piece oil control ring (two rails and one spacer-expander) with chromed rails. Forged high-alloy steel connecting rods with piston pins clamped in upper end and replaceable lower bearings. Forged alloy steel crankshaft with replaceable main bearings. Crankshaft main and connecting rod journals specially hardened for greater durability. Special wide-base main bearing caps with four-bolt attachment for firmer clamping. Premium aluminum main and connecting rod bearings. Machined cast alloy iron flywheel. Power plant mounted on rubber cushions, two front, one rear.

FUEL AND INDUCTION SYSTEM Special large four-barrel carburetor with automatic choke and oil-wetted paper-element air cleaner. Precision-cast alloy aluminum 8-port intake manifold with extra-large ports. Mechanical pulsator-type sealed fuel pump driven by camshaft. Sintered bronze fuel filter in carburetor, fine-mesh strainer in tank. Electric fuel gauge. Fuel tank capacity 20 gallons. Recommended fuel: special premium.

VALVE SYSTEM Valve-in-head, with independent operating mechanism for each valve. Formed steel rocker covers. Valve material: intake, alloy steel with aluminized face and head; exhaust, heat-treated high-alloy steel with aluminized face and head. Intake and exhaust valve stems chrome-flashed. Pressed-in valve guides: valve seats machined in cylinder heads. Variable-pitch valve springs. Pressed steel rocker arms with ball and socket mountings. Tubular steel push rods with hardened steel ball tips actuated by mechanical valve lifters. Special performance cast alloy iron

camshaft with wear-resistant coating, mounted in five steel-backed babbitt bearings and driven from crankshaft by silent chain.

EXHAUST SYSTEM Dual 2.5" system with oval reverse-flow mufflers. Precision-cast large free-flow alloy iron exhaust manifolds. Rolled lock seam muffler construction. Right side muffler: stainless steel heads, one and four baffles and outlet pipe, and asbestos-wrapped stainless steel body with aluminized cover. Left side muffler: aluminized heads and asbestos-wrapped aluminized body with aluminized interior and cover.

ELECTRICAL SYSTEM 12-volt, 61-ampere-hour battery and 9-37-ampere Delcotron diode-rectifying generator protected by voltage regulator. Positive-shift high-torque starter with solenoid-engaged drive pinion and overrunning clutch. Hermetically sealed ignition coil. Single-breaker distributor with combination centrifugal and vacuum spark advance. Non-metallic high-tension spark cables. Spark plugs: AC 43N normal service type with rubber boots. Delcotronic full-transistor ignition system (RPO K66) required added equipment.

COOLING SYSTEM Pressurized liquid type with full-length water jackets completely surrounding cylinder barrels. Centrifugal high-capacity water pump with sealed double-row bearing, capacity 82 gallons per minute at 5200 engine rpm. Cross-flow radiator, 382-sq.-in. frontal area. 15-lb. pressure cap and pellet-type thermostat for quick warm-up. Five-blade temperature-controlled viscous drive fan, 17.1" diameter with circular shroud. Double-belt water pump and fan drive.

LUBRICATION SYSTEM Controlled full-pressure type with high-output oil pump and full-flow replaceable element oil filter. Refill capacity five quarts (six with filter replacement). Gear-type oil pump with fixed intake develops normal 50-75 p.s.i. oil pressure at 2000 engine rpm. Closed positive-type crankcase ventilation standard.

CORVETTE BODY FEATURES

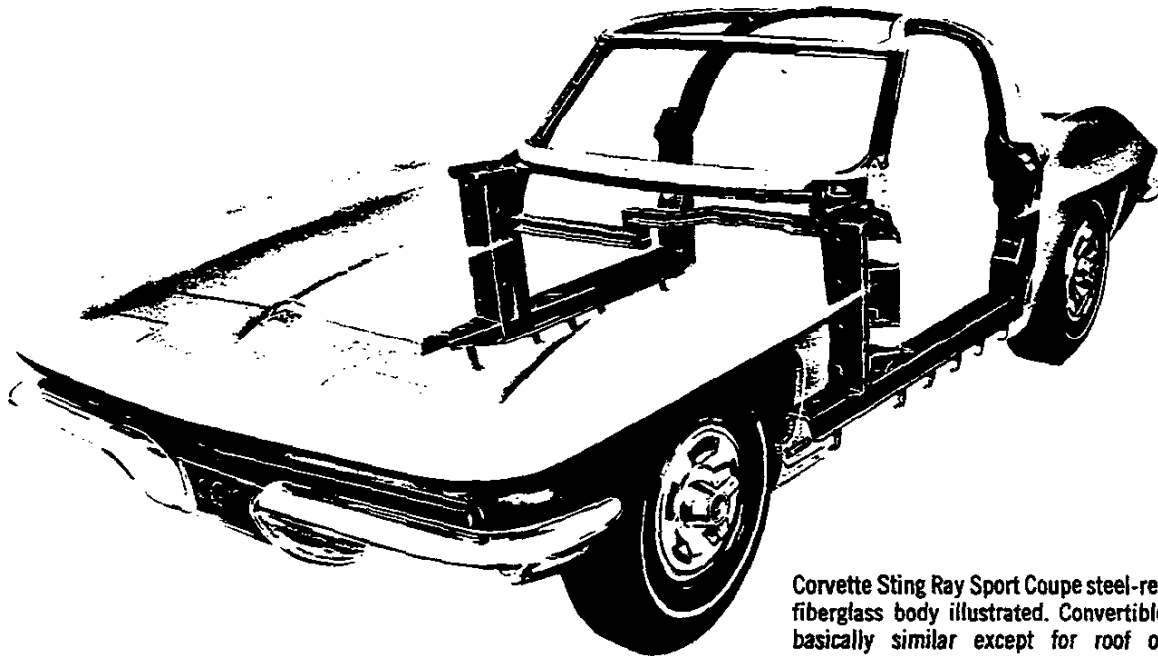

Corvette Sting Ray Sport Coupe steel-reinforced fiberglass body illustrated. Convertible model basically similar except for roof or other specific structure.

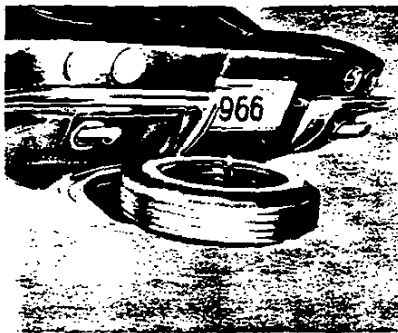

Spare tire stowage compartment with key lock located in underside of body.



Sport Coupe carpeted interior luggage compartment. Convertible similar except for folding top stowage.

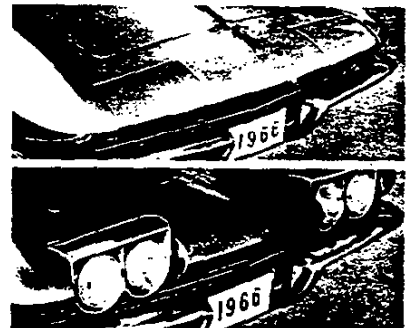

Power-operated retractable dual headlights—control switches and flasher warning light in instrument panel.

Engine compartment air exhaust louvers in front fenders.

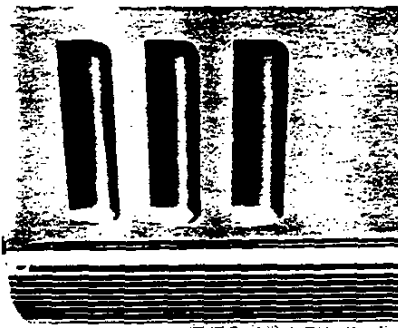

Special high-domed hood with optional 427-cu.-in. V8 engines.

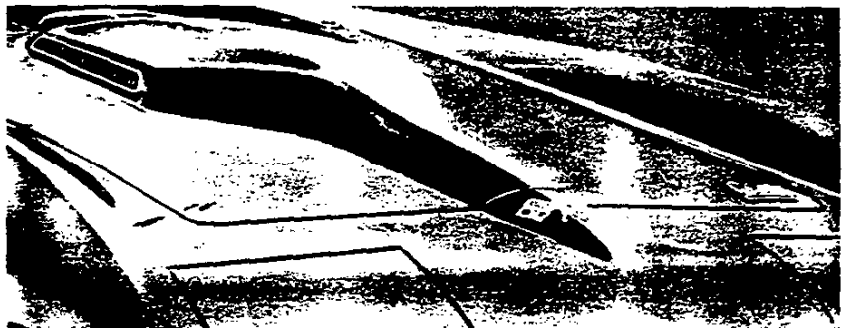

Body Structure

- Corrosion-proof steel-reinforced fiberglass body . . . lightweight, high-strength, impact-resistant fiberglass construction; one-piece underbody structure with fabricated-in steel structural members.
- Integrally bonded cowl structure formed of air ventilation plenum chambers, dash panel and underbody.
- Steel-reinforced body sills, door hinge pillars and lock pillars, plus lateral steel crossmember integrating front pillars. Sport Coupe roof structure features supporting members to enclose the passenger compartment with protective steel framing.
- Double-panel door construction with steel door lock and hinge reinforcements. Wrap-over Sport Coupe doors extend well into roof panel for easy entrance.
- Convertible top folds for stowage beneath double-locking spring-loaded cover panel.
- Double-panel reinforced front-hinged hood with telescoping automatic latch supports.
- Roomy inside luggage compartment behind front seats with concealed stowage space for tools and small valuables. Carpeted floor panel in forward end of compartment bridges drive-line tunnel forming flat load area. Vertical riser protects seat backs from possible luggage damage. Panel is easily removed for access to concealed stowage compartments.

Body Mounting

- Sport Coupe body is securely attached to frame at six points with special bolts and double-cushioned rubber mounts. Convertible body is solidly attached to the frame at eight points with four rubber and four hard fiber-composition mounts and special bolts.

Weathersealing

- Weathertight formed rubber windshield seal.
- Flush-mounted adhesively bonded rear window on Sport Coupe.
- Door glass and ventipane formed rubber seals.
- Convertible hardtop rear window formed rubber seals.
- Positive-sealing formed rubber Convertible folding top and hardtop seals at windshield, door glass edges, and at body mounting surfaces.
- Double-sealing door weatherseals on Sport Coupe.
- Formed rubber Convertible door weatherseals.

PLUS ALL THESE QUALITY FEATURES

- Padded instrument panel hoods
- Padded sun visors
- Inside rearview mirror with shatter-resistant glass
- Windshield washer and 2-speed electric windshield wipers with glare-reducing matte-chrome arms and blades
- Outside rearview mirror
- Back-up lights
- High-level ventilation system
- Built-in blended-air heater and defroster
- Front fender engine compartment air louvers
- Magic-Mirror acrylic lacquer finish
- Windshield with double-thick plastic center
- Power-operated retractable dual headlights
- Precision crank-operated compound-curved ventipanes
- Roll-down compound-curved solid tempered safety plate door window glass
- Two-key lock system
- Solid tempered safety plate Sport Coupe rear window glass
- Keyless door locking
- Pushbutton outside door handles
- Weather-shielded key locks
- Luxurious color-keyed interior trim
- Color-matched seat belts—retractors for outside belts, mounting clip on console for stowing inside belts
- Centrally located concealed fuel filler opening
- Full-view instrument panel with complete complement of instruments and controls, cigarette lighter, and locking glove compartment with automatic light

CORVETTE CHASSIS SPECIFICATIONS

Corvette Sting Ray rugged sports car chassis design with full independent 4-wheel suspension and rigid all-welded ladder-type sports car frame.

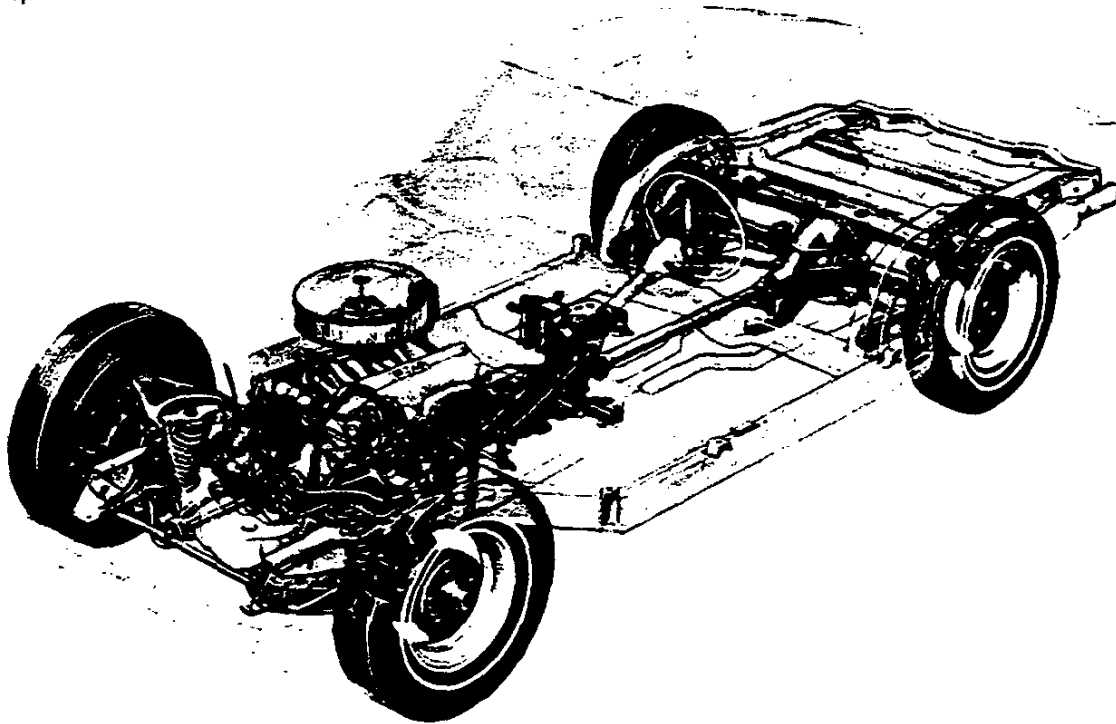

Frame

All-welded 5-crossmember ladder-type frame with trapezoidal-shaped sidemembers framing passenger area and extending forward forming engine support. Box-section design sidemembers from pickup rearward support axle and suspension.

Front Suspension

Independent coil spring spherical joint suspension with concentric springs and shock absorbers between upper and lower control arms. Built-in anti-dive control and rubber-bushed link-type stabilizer bar. Quiet, low-friction non-metallic spherical joint liners. Spherical joints protected by special positive-sealing formed-rubber boots.

Rear Suspension

Independent rear suspension with frame-mounted differential unit, double universal jointed tubular axles, and transverse multi-leaf spring. Differential carrier is mounted to frame by rubber-isolated crossmember. Nine element transverse leaf spring with hardened and tempered chrome carbon steel leaves bolts solidly to differential carrier and attaches to radius arms with

rubber-isolated floating rods. Suspension design permits spring to function as springing member only. Lateral and longitudinal forces imposed by braking, acceleration, and cornering are absorbed by frame-mounted fixed differential and suspension control arms.

Shock Absorbers

Direct, double-acting, sealed-unit hydraulic shock absorbers with special aeration-preventing freon bag in fluid reservoir. Front shock absorbers concentrically located within coil springs and attached to lower control arms and frame crossmember. Rear shock absorbers mounted between wheel spindle supports and frame.

Steering System

Balanced system with relay-type linkage and low-friction Ball-Race steering gear. Rubber-insulated jointed steering column helps cushion road shock and vibration. Overall steering ratio: standard steering—20.2:1 (linkage may be adjusted for special fast overall steering ratio—17.6:1); power steering—17.6:1. Steering wheel diameter—16 inches. Steering wheel turns stop to stop: standard ratio—3.4, optional* power steering and special fast ratio—2.9.

*Optional at extra cost.



Relay type steering linkage and low-friction Ball-Race steering gear with rubber-cushioned jointed steering column.

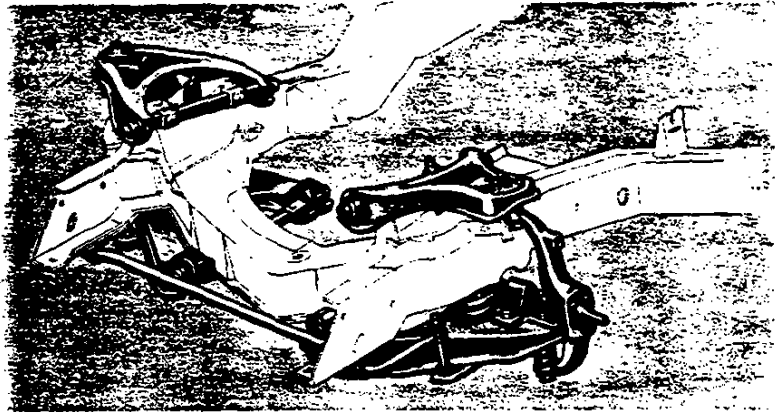

Corvette independent coil spring spherical joint front suspension with stabilizer bar.

Self-adjusting Sport-Master caliper-type disc brake.

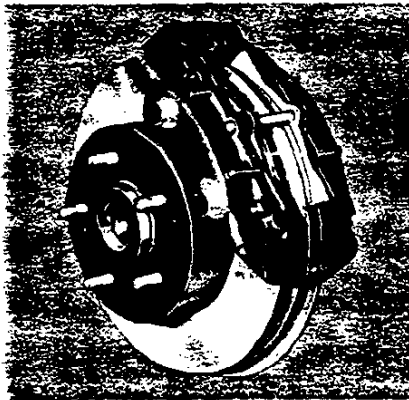

Corvette independent rear suspension with frame-mounted differential unit and special nine element transverse leaf spring.

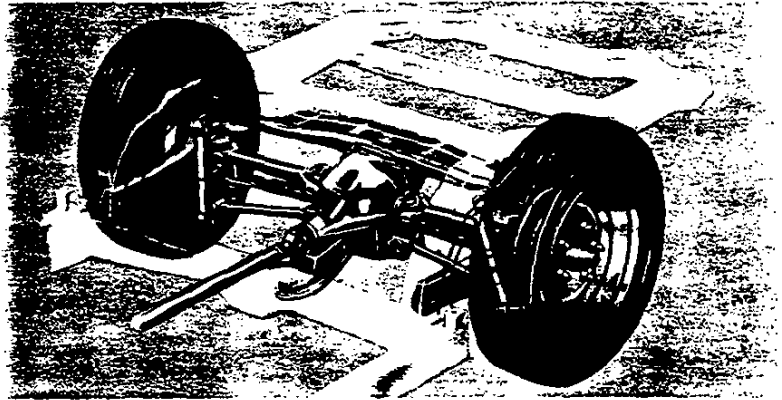

Drive Shaft

Balanced single-unit tubular steel drive shaft with universal joints joining shaft ends to transmission and axle.

Parking brake operation by T-handle control to left of steering column.

Rear Axle

Hypoid gear design with cast iron housing. Lubricant capacity—3.7 pints. For specific details see *Power Teams* or *Feature Details* section.

Mufflers

Long-life dual reverse-flow type mufflers fabricated of highly corrosion resistant materials. For specific information see *Power Teams* section—*Engine Specifications*, or *Feature Details* section.

Brakes

Self-adjusting 4-wheel caliper-type disc brake system. Brake disc diameter—11.75". Lining size (length x width x thickness)—5.96" x 2.21" x .41". Total lining area—86.3 sq. in. Braking distribution—front: 65%, rear: 35%. Woven asbestos composition lining bonded to brake shoes. Cast iron brake discs with radial internal fins for rapid heat dissipation. Independent mechanical parking brake system—6.5" diameter internal drum with two shoes and riveted linings at each rear wheel.

Wheels and Tires

Welded steel short-spoke spider type 15" wheels with special cooling slots to circulate air around brakes. Rim width—5.5". Black sidewall highway rayon 7.75 x 15 4-ply rating tires standard . . . white sidewall tires optional*. All wheels and tires statically balanced for smoother, quieter operation and longer tire life. For additional information, see *Tires* in *Feature Details* section; optional* tires listed in *Options and Accessories* section.

*Optional at extra cost

SPECIAL CHASSIS EQUIPMENT—For complete list of special options see *Options and Accessories* section.

CORVETTE FACTORY-INSTALLED OPTIONAL EQUIPMENT

	RPO		RPO
AIR CONDITIONING, FOUR-SEASON —Not available with 425-hp V8 engine. Includes 61-ampere Delcotron Generator	C60	LEATHER SEAT TRIM —Available in Black, Red, Bright Blue, Saddle and Silver. See Sales Album, Colors and Fabrics section.	
AXLE, POSITRACTION REAR —See Power Teams, page 4, for available axle ratios	G81	RADIO AND POWER ANTENNA, AM-FM	U69
BRAKES, HEAVY-DUTY —For use with 390-hp or 425-hp V8 engine	J56	STEERING COLUMN, TELESCOPIC	N36
BRAKES, POWER	J50	STEERING, POWER	N40
EMERGENCY ROAD KIT —Fire extinguisher, flares, fuses, tire repair kit and inflator, and distress flag	Z83	STEERING WHEEL, GENUINE TEAKWOOD	N32
ENGINES:		SUSPENSION, SPECIAL-PURPOSE FRONT AND REAR —Includes special springs, matching shock absorbers, and special front and rear stabilizer bars. Available with 425-hp V8 only	F41
350-hp Turbo-Fire 327—(V8)	L79	TANK, FUEL —36-gal. For Sport Coupe only. Includes wheelhouse filler panel	N03
390-hp Turbo-Jet 427—(V8) . Available with Positraction axle only	L36	TIRES: For additional information, see Tires in Feature Details section.	
425-hp Turbo-Jet 427—(V8) . Available with Positraction axle and Full Transistor Ignition system	L72	7.75 x 15—Blackwall , highway rayon 4 pr tubeless	Standard
EXHAUST SYSTEM — Off-road service. Available with any optional engine with 4-Speed transmission	N11	7.75 x 15—Whitewall , highway rayon 4 pr tubeless	P92
EXHAUST SYSTEM, DUAL SIDE MOUNTED —Off-road service only	N14	7.75 x 15—Gold-Stripe , special nylon 4 pr tubeless	T01
GLASS, SOFT-RAY TINTED —All windows	A01	TOP, CONVERTIBLE —Choice of white, black, or beige. See Sales Album, Colors and Fabrics section	C05
GLASS, SOFT-RAY TINTED —Windshield only ...	A02	TRAFFIC HAZARD WARNING SYSTEM	V74
GM AIR INJECTION REACTOR —Includes closed engine positive ventilation. California registered vehicles only. Not required with 425-hp V8 engine	K19	TRANSMISSIONS:	
HARDTOP, REMOVABLE —Fiber glass hardtop optional at no extra cost in place of convertible folding top, or in addition at extra cost	C07	4-Speed Fully Synchronized — (Wide-Range) . Available with 300-, 350- and 390-hp V8 engines	M20
HEADRESTS, STRATO-EASE	A82	4-Speed Fully Synchronized — (Close-Ratio) . Available with all optional engines	M21
HEATER AND DEFROSTER DELETION — Credit option. Not available with Air Conditioning..	C48	4-Speed Heavy-Duty Fully Synchronized —For use with 425-hp V8 engine. Not recommended for normal usage	M22
IGNITION SYSTEM, FULL-TRANSISTOR —Available with 350-, 390- and 425-hp V8 engines	K66	Powerglide —With 300-hp V8 engine only	M35
		WHEELS, SPECIAL CAST ALUMINUM —Set of five 15 x 6L wheels. Includes four adapters, four 3-lug knock-off hubs, and special knock-off hammer	P48
		WINDOWS, POWER	A31

CORVETTE DEALER-INSTALLED CUSTOM FEATURE ACCESSORIES*

	Part No.		Part No.
ANTENNA, ELECTRIC —Left Rear	986305	LITTER CONTAINER —Saddle Type	
CAP, LOCKING GAS FILLER	985919	Black	986607
CARRIER, DECK LID —Sport Coupe only	986469	Blue	986602
CARRIER ADAPTER, DECK LID	986451	Red	986608
COMPASS	986298	Fawn	986603
EXTINGUISHER, FIRE —2¾-lb. dry chemical ..	985592	MIRROR, INSIDE —Non-Glare	986600
EXTINGUISHER, FIRE —5-lb. dry chemical	986276	RADIO AND POWER ANTENNA, AM-FM	
EXTINGUISHER, REFILL KIT	985593	327-cubic-inch engine	986476
FLOOR MAT, FRONT CONTOUR —Clear Vinyl ..	985882	427-cubic-inch engine	986478
LAMP, PORTABLE SPOT	987112	TISSUE DISPENSER —Instrument panel mounted (Not available with Air Conditioning)	986408
		TISSUE DISPENSER —Saddle type	
		Black	986609
		Blue	986604
		Fawn	986606
		Red	986610
		TOOL KIT	988032
		TRAFFIC HAZARD FLASHER SYSTEM	986639

Extra cost

ORIGINAL COPY

1966
CORVETTE
SPECIFICATIONS

DECEMBER 1965 REVISION

CHEVROLET ENGINEERING CENTER



**ENGINEERING PRODUCT INFORMATION DEPARTMENT
WARREN • MICHIGAN**

INTRODUCTION

In the automobile industry, a specification is defined as any item in a detailed description of a mechanism. Usually the description is composed of separate specifications in tabular question and answer form.

Specifications of this nature, however, are not required in the manufacture of an automobile. All the information necessary for this process is given by the Engineering Department to the manufacturing and assembling plants in the forms of drawings and parts lists. But drawings and parts lists usually are not made available to other people who require information of the vehicle, since these records must be interpreted. Moreover, they and other engineering records are much too numerous or voluminous for convenient reference. Therefore, a special interpretation is made by the Engineering Department in the form of a specifications list or book, the contents of which are determined by the nature of questions people ask the Engineering Department concerning the vehicle.

As has been the experience of most manufacturers, originally the questions asked were few in number and were answered individually at the time they were asked. Through the years, however, many questions were asked quite frequently and, for convenience, the answers were recorded in the form of specifications. Others, which arose because of heightened interest and because of advancements in design, were added from time to time. As the automobile grew into a necessary means of transportation --- as its component units were advanced in design and as new ones were added --- and as manufacturers were forced to make more detailed comparisons of their vehicles with those of their competitors to satisfy an increasingly technically minded public --- more and more questions concerning the various characteristics of vehicles were answered in the form of specifications.

The Chevrolet Engineering Department has always been willing to answer questions of a technical nature concerning Chevrolet products and for the past years has endeavored to anticipate such questions by preparing a specifications book each new model year.

This current book has been prepared to answer all the questions concerning the Chevrolet 1966 products that we believe may be asked.

It is intended primarily as a convenient and authoritative source of information for all Chevrolet executives, engineers, sales and service representatives, plant managers, and other personnel who must be in a position to answer such questions, and also as a common source of those Chevrolet specifications that are needed in advertisements, vehicle comparisons, trade publications, license applications and in correspondence with governments, firms, educational institutions, and individuals throughout the world who require a wide variety of information about Chevrolet products for diverse purposes.

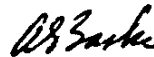

A. F. Baske

Director - Engineering
Product Information

GENERAL



MODEL IDENTIFICATION	2
SERIAL NUMBERS AND IDENTIFICATION	2
REGULAR EQUIPMENT - INTERIOR	3
REGULAR EQUIPMENT - EXTERIOR	4
REGULAR PRODUCTION OPTIONS	5
DEALER INSTALLED ACCESSORIES	5
INTERIOR DIMENSIONS	6
EXTERIOR DIMENSIONS	7
VEHICLE WEIGHTS	8
EXTERIOR PAINT PROCESS	8
EXTERIOR-INTERIOR COLOR COMBINATIONS	9
BODY GLASS	9
BODY CONSTRUCTION	9

MODEL AND SERIAL NUMBER IDENTIFICATION

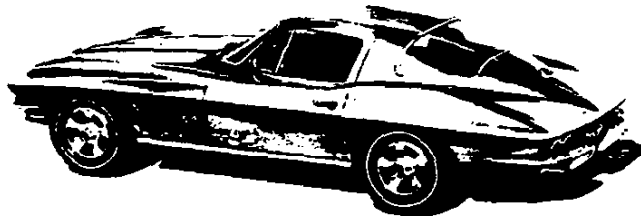

Model 19437 2-Door Sport Coupe, 2-Passenger.

Model 19467 2-Door Convertible, 2-Passenger

VEHICLE SERIAL NUMBER

Example:

Model	Year	Assembly Plant (St. Louis)	Unit Number (25th Unit)
19437	6	S	100025

Thus: The 25th model built at St. Louis would be serial number 194376100025

Starting unit number ----- In numerical sequence beginning with 100001
 Location ----- On plate, R.H. side of hinge pillar cross brace under glove

ENGINE IDENTIFICATION

Example: F 1210 HE

Source Designation	Production Month & Date	Type Designation
F(Film)	12 10	HE

327 Cubic Inch V-8

HE - Regular production engine
 HT - RPO L79 4-barrel, hyd. lifters

427 Cubic Inch V-8

IL - RPO L36, 4-barrel, hyd. lifters
 IP - RPO L72, large 4-barrel, spec. cam

Location ----- Stamped on top front of RH bank of cylinder and case

REAR AXLE IDENTIFICATION

Example: AK 0212 W

Type Designation	Production Month & Date	Source Designation
AK	02 12	W(Warren)

Regular axles

AK ----- 3.36:1
 AS ----- 3.70:1

Positraction axles

AL ----- 3.08:1
 AM ----- 3.36:1
 AN ----- 3.55:1
 AO ----- 3.70:1
 AP ----- 4.11:1
 AQ ----- 4.56:1

Location ----- Bottom edge of differential carrier flange

REGULAR EQUIPMENT—INTERIOR

	Armrest on each door and between seats	
	Ash tray (on seat separator)	
Bright metal surfaces	Direction signal control lever and knob	All models
	Floor tunnel cover plate & molding	
	Glove box door trim plate, emblem and molding	
	Instrument cluster trim and control knobs	
	Instrument panel console control knobs	
	Parking brake handle	
	Rear view mirror and support	
	Seat adjustment handle	
	Seat backrest side trim	
	Seat belt keeper plates	
	Side door hardware and panel molding	
	Sill plates	
	Steering wheel spokes and horn button bezel	
	Top header release latches	
Transmission shift lever and knob	All models	
Transmission shift lever bezel, ash tray door and shift pattern diagram		
Windshield upper and side garnish moldings	Model 19467	
	Bucket seats with individual fore-aft adjustment	All models
	Compound curved door glass	
	Cowl vents with bowden cable controls	
	Direction signal control	
	Door closing handle	
	Door locking knob	
	Door opening handle with ball-shaped knob	
	Door side window crank handle	
	Door vent window crank handle	
	Electric clock with second hand (on instrument panel console)	
	Glove compartment with trim panel, emblem and key lock	
	Heater controls (on instrument panel console)	
	Hood release control	
Instrument cluster	Ammeter	
	Cigarette lighter	
	Clock	
	Direction signal indicators	
	Fuel gauge	
	Headlamp hi-beam indicator	
	Headlamp position warning indicator	
	Headlamp rotation switch	
	Ignition switch (4-position)	
	Main light switch	
	Oil pressure gauge	
	Parking brake alarm	
	Simulated vinyl trim plate	
	Speedometer (160 mph) with odometer	
	Tachometer (7000 rpm)	
Temperature gauge		
Trip odometer with reset stem		
Windshield washer and wiper control switch	Model 19437	
Interior lighting	Dome	All models
	Glove compartment	
	Heater controls	
	Instrument cluster controls and gauges	
	Instrument panel courtesy, left and right	Model 19467
	Rear compartment courtesy	
	Padded sun shades	All models
	Parking brake control	
	Passenger compartment carpeting, molded	
	Rear compartment carpeting, molded	
	Rear view mirror	
	Seat belts with stowage provisions	
	Steering wheel (simulated wood grain) with competition-type 3-spoke design, and horn button	All models
	Transmission shift pattern diagram (on seat separator)	
	Two-speed electric windshield wiper with washer	
	Vinyl covered instrument panel hoods; passenger assist in right hood	

REGULAR EQUIPMENT - EXTERIOR

Bright metal surfaces	Body sill moldings (black paint fill)		All models	
	Bumpers, front and rear			
	Door handles and key locks			
	Gas filler door and bezel			
	Radiator grille			
	License plate bezel, rear			
	License plate frame support, front			
	License plate frames			
	Outside rear view mirror, left hand door			
	Parking and direction signal lamp bezels			
	Rear window reveal			Model 19437
	Tail pipe extensions and bezels			All models
	Tail, stop and direction signal lamp bezels			
	Back-up lamp bezels			Model 19467
	Vent window frames			
Windshield pillar molding (19467)				
Windshield reveal moldings		All models		
Wheel discs and ornaments				
Emblems	Crossed flags		Body front panel	
			Front fender side	
			Wheel disc ornaments	
			Gas filler door	
Name plates	Name plates		Rear deck	
			Hood	
Exterior lighting	Headlamps, dual, retractable			
	Parking and direction signal lamps (amber lenses)			
	Rear license lamp			
	Tail, stop direction signal and back-up lamps			
Function front fender louvers				
Integral front and rear bumper guards				
Manual folding top			Model 19467	
Spare tire well cover lock			All models	

REGULAR PRODUCTION OPTIONS

● BODY OPTIONS

Air conditioning	C60	All
Auxiliary top equipment	C07	19467
Folding top	C05	
Headrest, conventional type seat	A82	All
Less heater equipment	C48	
Power windows	A31	
Radio, AM-FM (remote control antenna)	U69	
Shoulder harness	A85	
Switch, traffic hazard lamp	V74	
Tinted body glass	A01	
Tinted windshield	A02	

● ENGINE OPTIONS

327 cubic inch V-8 350 HP	L79	All
427 cubic inch V-8 390 HP	L36	
427 cubic inch V-8 425 HP	L72	
Air injection reactor	K19	
Cylinder heads aluminum	L89	
Gasoline tank, 36.5 gallon	N03	19437
Off-road exhaust equipment	N11	All
Side mounted exhaust system	N14	
Transistor ignition equipment	K66	

● CHASSIS OPTIONS

Brakes	Heavy duty	J56	All
	Power	J50	
Power steering	M40		
Rear axle positraction	G81		
Suspension, special performance front and rear	F41		
Steering wheel, wood	N32		
Telescoping shaft steering	N36		
Tires	7.75 x 15-Apr rayon, whitewall	P92	
	7.75 x 15-Apr nylon, gold stripe	T01	
15 x 6L wheel (quick take-off)	P48		

TRANSMISSION OPTIONS

4-speed manual transmission	M20	All
4-speed manual transmission - close ratio	M21	
4-speed manual transmission, heavy duty	M22	
Powerglide automatic transmission	M35	

DEALER INSTALLED ACCESSORIES

Antenna, radio (remote control)	All
Compass	
Fire extinguisher	
Floor mat (clear vinyl)	
Gas cap, locking	
Lamp switch and flasher, traffic hazard	
Luggage carrier, deck lid	
Luggage straps	
Mirror, (glare proof) rear view	
Mirror, outside rear view; replacement kit	
Radio, AM-FM	
Radio shielding installation unit	
Road hazard package	
Spotlamp, portable	
Seat cushion, ventilated	
Tissue dispenser	
Tool kit	

INTERIOR DIMENSIONS

Code*	Description*	Models		
		19437	19467 Soft-top	19467 Hardtop
L31	Body zero line to H point		44.5	
H70	Body zero line to H point		7.7	
H61	Effective head room	37.0		38.5
H37	Headlining to roof height	.38	--	.33
L34	Maximum effective leg room - accelerator		42.7	
H30	H point to heel point		3.9	
H67	Depressed floor covering thickness		.31	
L40	Back angle (degrees)		28	
L42	Hip angle (degrees)		102	
L44	Knee angle (degrees)		135	
L46	Foot angle (degrees)		82	
H65	D point differential, side to center		--	
H54	D point to tunnel		1.9	
L53	H point to accelerator floor point		35.8	
L17	H point travel		4.0	
H58	H point rise		.32	
H5	H point to ground	15.4		15.4
FRONT COMPARTMENT				
W3	Shoulder room		48.4	
W5	Hip room		50.9	
W16	Seat width (each seat)		21.6	
H50	Upper body opening to ground	46.8		45.6
H11	Entrance height	31.4		30.2
H115	Step height (design load)		14.0	
H130	Step height (curb load)		16.2	
L18	Entrance foot clearance		16.5	
H32	Seat cushion deflection		3.1	
L14	Seat back thickness		3.9	
W1	Hat room	45.1		39.3
H3	Seat chair height		9.0	
H26	Interior body height, M/M @ car Centerline	36.2		35.9
H27	Interior body, M/M @ C/LO	40.7		41.6
				40.6
SEAT AND ENTRANCE - FRONT				
H6	H point to W/S bottom DLO		19.9	
H64	H point to W/S upper DLO		30.6	
L49	H point to W/S upper DLO		16.4	
H25	Belt height		18.0	
W7	Steering wheel center to car Centerline		12.8	
W9	Steering wheel maximum OD		16.0	
H18	Steering column angle (degrees) - horizontal		16.45	
H49	H point to top of steering wheel		23.3	
L7	Steering wheel torso clearance		13.2	
H13	Steering wheel thigh clearance		4.5	
L13	Brake pedal knee clearance		24.6	
L52	Brake pedal to accelerator		2.8	
W122	Tumble-home (degrees)		20.0	
VISION AND CONTROL				

* Code and description conform generally to AMA Specifications.

EXTERIOR DIMENSIONS

		Models			
		19437	19467 Soft-top	19467 Hardtop	
WIDTH	Code • Description •				
	W101 Tread - front		56.8		
	W102 Tread - rear		57.6		
	W103 Max. overall car width		69.2		
	W116 Max. overall body width		(see W106)		
	W106 Front fender overall width		69.6		
	W107 Rear fender overall width		67.3		
W120 Max. overall width - doors open		139.3			
HEIGHT	H101 Overall height	49.6	49.8		
	H114 Hood at rear to ground		34.8		
	H112 Rocker panel to ground - front		8.0		
	H111 Rocker panel to ground - rear		8.0		
	H132 Bottom of door to ground, open		13.5		
	H133 Bottom of door to ground, closed		12.5		
	H122 W/S slope angle (degrees)		56.5		
	H136 Body zero to ground - front		7.7		
	H137 Body zero to ground - rear		7.7		
	H125 Headlamp to ground		24.4		
	H126 Tail lamp to ground		21.8		
	H158 Roof thickness		3.7	4.4	
	H159 DLO height		12.5	12.2	
	H160 Body thickness		25.5		
LENGTH	L30 Body zero line to actual front of dash		2.57 (fore of dash)		
	L101 Wheelbase		98.0		
	L104 Overhang - front		31.9		
	L105 Overhang - rear		45.2		
	L103 Overall length		175.1		
	L128 Hood length at car C/L		46.7		
	L123 Body upper structure length @ car C/L		77.9	66.8	69.2
	L129 Deck length @ car C/L		28.6	39.7	37.3
	L127 Body zero line to C/L rear wheels		72.0		
	L130 Body zero line to W/S cowl point		9.0		
L102 Tire size		7.75 x 15			
CLEARANCE AND GLASS AREA-HEIGHT	H102 Front bumper to ground		18.0		
	H104 Rear bumper to ground		16.6		
	H106 Angle of approach (degrees)		26.29		
	H107 Angle of departure (degrees)		17.14		
	H147 Ramp breakover angle (degrees)		11.75		
	H148 Front suspension to ground		8.0		
	H149 Oil pan to ground		6.0		
	H150 Flywheel housing to ground		5.9		
	H151 Frame structure to ground		5.5		
	H152 Exhaust system to ground		5.0		
	H153 Rear axle differential to ground		7.8		
	H154 Fuel tank to ground		—		
	H155 Spare tire well to ground		6.1		
	H156 Minimum running ground clearance		5.0 (see H152)		
S1 Windshield glass area (sq. inches)		789.7			

• - Code and Description conform generally to AMA Specifications.

VEHICLE WEIGHTS

VEHICLE WEIGHTS, LB

Weight of basic vehicle - 300 HP engine and
3-speed transmission

Model 19467 soft top

Shipping weight	
Front -----	1530
Rear -----	1475
Total -----	3005
Curb weight	
Front -----	1525
Rear -----	1635
Total -----	3160
Design weight	
Front -----	1605
Rear -----	1855
Total -----	3460

Model 19437 Sport Coupe

Shipping weight	
Front -----	1555
Rear -----	1430
Total -----	2985
Curb weight	
Front -----	1525
Rear -----	1635
Total -----	3140
Design weight	
Front -----	1605
Rear -----	1855
Total -----	3460

Model 19467 hardtop ----- Add 8 lb to soft top values
Powerglide transmission ----- Add 23.3 lb

EXTERIOR PAINT PROCESS

- 1. PRIMARY SANDING.** All body panels and bonded joints that receive acrylic lacquer are dry sanded to prepare surfaces for painting. A filler material, called putty rub, is applied to the entire body to fill minor imperfections.
- 2. PRIMER.** Two coats of primer are applied -- the first red and the second gray -- and are oven baked for 60 minutes at 280 degrees F.
- 3. WET SANDING.** The body is wet sanded to provide a smooth surface for the sealers. Most of the gray primer coat is removed with the red primer acting as a depth signal for the sanding operation. The body is dried to remove all moisture.
- 4. SEALER.** One coat of sealer and one coat of color acrylic lacquer are applied and baked.
- 5. DRY SANDING.** The body is dry sanded to prepare surfaces for the final acrylic lacquer.
- 6. LACQUERING.** Three coats of acrylic lacquer are sprayed on the body to build up the required paint thickness. The paint is "rested" for eight minutes to permit it to partially set up and to remove excess volatile paint vehicle.
- 7. INITIAL BAKING.** The body is oven baked for 30 minutes at 140 degrees F to harden the paint which permits the subsequent operation. Small interior and exterior parts are painted to complete the body paint schedule.
- 8. FINAL BAKING.** To assure a durable, hard, high luster finish the lacquer is oven baked for 45 minutes at 250 degrees F. Reheating the lacquer permits the paint film to soften and allows surface blemishes and sanding scratches to disappear during the thermo-reflow process.
- 9. FINAL SANDING AND POLISHING.** The body is lightly oil sanded and polished to bring painted surfaces to a high luster finish.

EXTERIOR-INTERIOR COLORS

INTERIOR-EXTERIOR COLOR COMBINATIONS

EXTERIOR			INTERIOR TRIM COLORS AND RPO NUMBERS						
			Black	Red	Bright Blue	Med. Saddle	Silver	White Blue	Dark Blue
RPO	Color	Sales Name	Models 19437-67						
			Reg. Prod.	407	414	420	426	450	418
900	Black	Tuxedo Black	X	X	X	X	X	X	X
972	White	Ermine White	X	X	X	X	X	X	X
974	Red	Rally Red	X	X					
976	Brt. Blue	Nassau Blue	X		X			X	X
978	Dk. Teal Blue	Laguna Blue	X		X				X
980	Silver Blue	Trophy Blue	X		X				X
982	Silver Green	Mosport Green	X						
984	Yellow	Sunfire Yellow	X						
986	Silver	Silver Pearl	X				X		
988	Maroon	Millano Maroon	X			X			

Convertible top: Black, white, or beige with any exterior color.
 * - Genuine leather seat trim option.

BODY GLASS

LOCATION		TYPE	MODELS	
			19437	19467
			AREA	
Windshield		1-piece curved	789.7	
Side Door	Door	Curved	528.3	442.8
	Ventipane	Curved	91.8	107.3
Back Window	Softtop	Flat, 1-piece	440.5	
	Hardtop	Curved, 1-piece	888.2	
	Sport Coupe	Curved, 1-piece	821.5	
Total visibility			2231.3	Softtop 1780.3 Hardtop 2228.0

BODY CONSTRUCTION

GENERAL

Construction ----- Uniconstruction: fiber glass reinforced plastic body backbone by a steel cage outlining the passenger compartment. Principal members - underbody, front and rear end assemblies, dash panel, roof (Model 837) and hinge pillars are bonded, riveted, or bolted together and to each other. Hood is plastic with bonded plastic reinforcement.

DOOR AND LOCKS

Construction ----- Plastic, double paneled, reinforced with steel at hinge and lock locations. Front hinged.
 Door handles ----- Push button with rotary type latches. Inside door locking knob on each door (upper reflector on side wall trim)
 Door ventipanes operation ----- Crank

HOOD

Operation ----- Internal release lever. Front hinged with telescoping link on right side. Ratchet-type lock for hold open.

VENTILATION

Type ----- "Saddlebag"
 cowl top air inlets channel air to cowl side kick panel outlets controlled by bowden cable operated valves. Water drainage at base of "saddlebag" plenum chambers.

SEATS

Type and construction ----- Bucket: leather grained vinyl covering over polyurethane padding

WINDSHIELD WIPERS

Type ----- Dual, two-speed, electric; washer provided
 Linkage ----- Parallel acting

SPARE TIRE

Location ----- In well under fuel tank; accessible from underside of car. Cover with key lock provided.

TOOLS

Type ----- Scissors jack, and combination jack handle and lug wrench
 Stowage ----- In well in luggage area directly behind drivers seat; carpeted cover over well.



(

(

(



CHASSIS

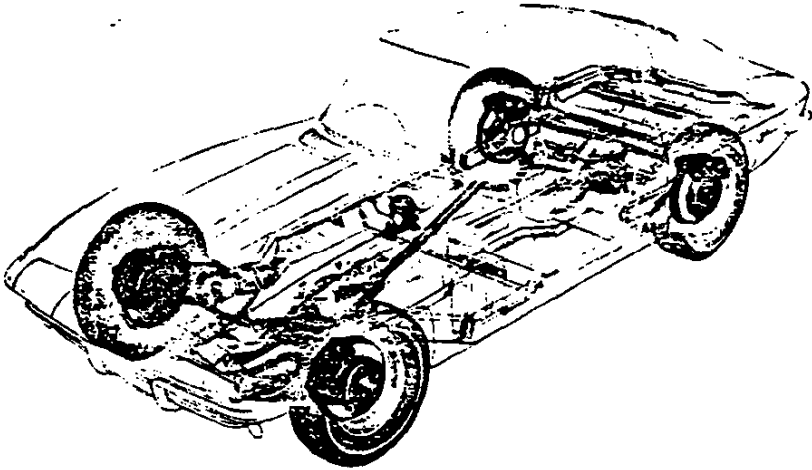

FRAME 2

FRONT SUSPENSION 2

STEERING 4

DRIVELINE 5

REAR SUSPENSION 5

REAR AXLE 6

BRAKES 8

WHEELS AND TIRES 9

BULBS, FUSES, AND CIRCUIT BREAKERS 9

FRAME

GENERAL

Description ----- All welded, full length, ladder constructed frame with 5 crossmembers. Side rails and intermediate crossmembers box section; front crossmember box girder section.

Dimensions

Width between	
No. 4 body mounting holes -----	49.32
No. 3 body mounting holes -----	55.14
No. 1 body mounting holes -----	55.14
Front end mounting holes -----	36.62
Length between	
No. 4 body mounting holes and front end mounting holes -----	130.82
No. 3 body mounting holes and front end mounting holes -----	93.32
No. 1 body mounting holes and front end mounting holes -----	41.92
Height between (measured at top of holes exc. frt. end)	
No. 4 and No. 3 body mounting holes -----	6.96
No. 4 and No. 1 body mounting holes -----	6.98
No. 4 body and front end mounting holes -----	7.90

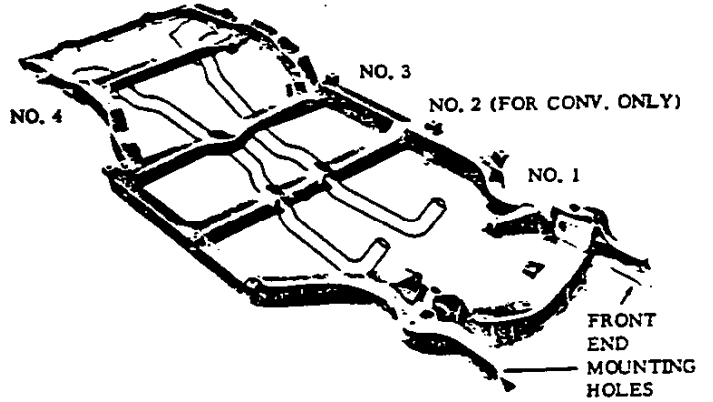

FRONT SUSPENSION

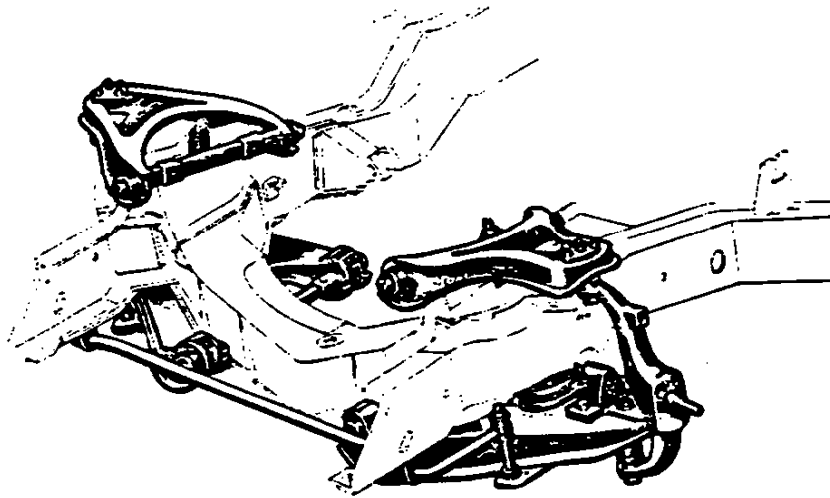

GENERAL

Description ----- Independent, SLA type with coil spring and concentric shock absorber, and spherically-jointed steering knuckle, for each wheel. Adjustments to front suspension are achieved with shims at pivot shafts.

Wheel travel, from design height -----
Jounce ----- 3.75
Rebound ----- 4.00
Wheel to spring ratio ----- 1.89:1

CONTROL ARMS

Description -----
Upper and lower ----- Each is stamped
A frame rubber-bushed at pivots.

Bushings -----
Type ----- Pre-loaded, steel encased rubber.

STEERING KNUCKLES

Description ----- Forged steel with detachable steering knuckle arm.

Spindle diameters -----
At inner bearing ----- 1.2493-1.2498
At outer bearing ----- .7492-.7497
Spindle thread size ----- 3/4-20 NEF-3 (modified)

FRONT SPRING

Part number ----- 3851100
Type ----- Right hand helix, variable rate
Material ----- AISI A-5160, heat treated
Cut-off length ----- 168.50
Number of coils (active, total) ----- 10.67, 12.00
Wire dia (theoretical) ----- .600
Outside dia, max. at ends (theoretical) ----- 5.19
Pitch dia (theoretical) ----- 4.40
Height -----
Free ----- 15.40
Working (inches @ lb) ----- 6.58 @ 1957,
8.56 @ 1340 (design load), 10.65 @ 932
Deflection rate (lb per inch) @ design load -----
@ Spring ----- 195
@ Wheel (wheel rate) ----- 80

FRONT WHEEL ALIGNMENT

Design -----
Camber (degrees) ----- 0 to P1
Caster (degrees) ----- P1-1/2 to P2-1.2
Toe-in, per wheel ----- 1/16

Curb -----
Camber (degrees) ----- P1.4 to P1-1.4
Caster (degrees) ----- P1 to P2
Toe, total ----- 7/32 to 11/32 toe in
Steering axis inclination (degrees) ----- 6-1.2 to 7-1.2

WHEEL BEARINGS

Type ----- Taper roller
Quantity ----- Two per spindle

SPHERICAL JOINTS

Type ----- Ball studs, upper self-adjusting for wear.

Bearing surfaces -----
Upper ----- Two surfaces, both non-metallic, the upper surface, a teflon-coated phenolic; the lower surface, a teflon-cotton composition
Lower ----- One upper surface, a teflon-cotton composition
Lubrication ----- High pressure grease fitting for each ball stud

SHOCK ABSORBERS

Type ----- Direct, double-acting, hydraulic; freon filled envelope in reservoir
Piston diameter ----- 1.00

STABILIZER BAR

Type ----- Link
Material ----- HR steel
Diameter ----- 327 V-8, .750; 427 V-8, .875
Bushing material ----- Natural or synthetic rubber

STEERING

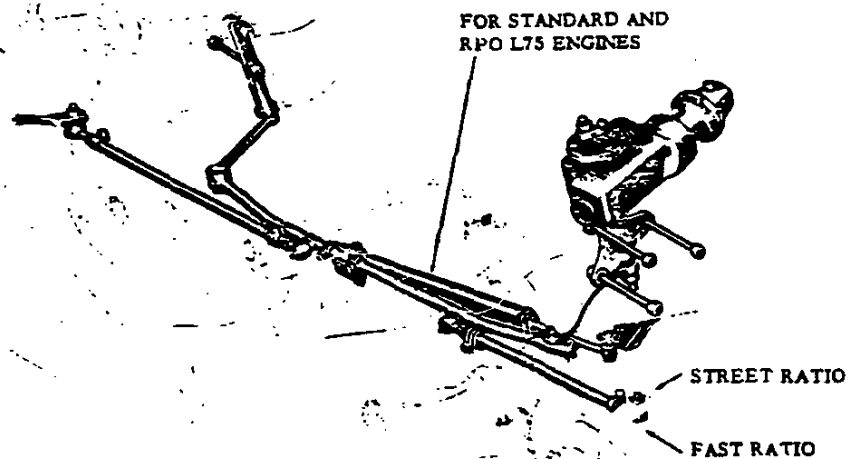

MANUAL STEERING, regular production

Description ----- Semi-reversible, recirculating ball nut steering gear with three-inch axial column adjustment; two-location steering arm-tie rod connection for street and fast ratio. Telescoping shaft steering available optionally.

System ratios	
Steering gear -----	16:1
Overall ratio -----	
Street -----	20.2:1
Fast -----	17.6:1
Turning characteristics	
Turning diameters (ft)	
Outside front, wall to wall -----	41.6
Outside front, curb to curb -----	39.9
Inside rear, wall to wall -----	25.6
Inside rear, curb to curb -----	25.6
Number of wheel turns, lock to lock	
Street -----	3.4
Fast -----	2.92
Outside wheel angle with inside wheel	
@ 15 degrees -----	14.23
@ 30 degrees -----	25.43
@ 34 degrees (limit of turn) -----	27.37
Steering shaft	
Number -----	1
Diameter -----	.75

Steering wheel

Type -----	Deep dished
Diameter -----	16.0
Linkage	
Type -----	Parallelogram
Location -----	Rear of wheels
Number of tie rods -----	2
Lubrication points -----	5; one at each tie rod; one at pitman arm-relay rod connection

POWER STEERING, RPO N40

(same as MANUAL STEERING except as follows)

Description -----	Hydraulic; pump powered cylinder assisting linkage
System ratios	
Steering gear -----	16:1
Overall -----	17.6:1
Number of wheel turns, lock to lock -----	2.92
Outside wheel angle with inside wheel	
@ 15 degrees -----	14.06
@ 30 degrees -----	25.17
@ 34 degrees (limit of turn) -----	27.20
Lubrication -----	Two additional fittings, at cylinder piston rod ball stud, and at valve adapter

DRIVE LINE

PROPELLER SHAFT

Type ----- Exposed, unsupported
Number used ----- 1
Construction ----- Welded
steel tubing incorporating yoke at each end
Tube
OD ----- 1.995-2.003
Wall thickness ----- .092-.097
Length between axis of yoke bores ----- 29.90

REAR SUSPENSION

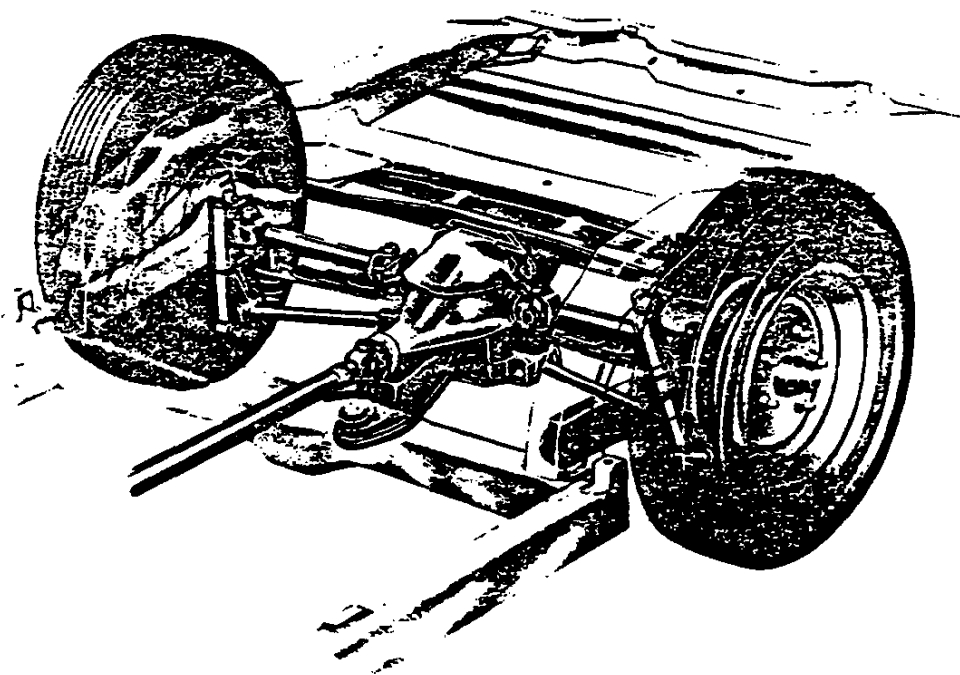

GENERAL

Description ----- Full independent with frame-anchored differential. Locus of each wheel established by 3 links: universally-jointed axle drive shaft and adjacent strut, and torque control arm pivoted at frame side rail. Vertical suspension loads taken by shock absorbers and transversely-positioned leaf spring. Built-in camber adjustment at struts.

Wheel travel, from design height -----
Jounce ----- 3.17
Rebound ----- 4.00
Wheel to spring ratio ----- .90:1

REAR SPRING

Type ----- Multi-leaf, 9 leaves
Material ----- Chrome carbon steel, heat treated
Length (developed) between eye centers ----- 46.36
Width ----- 2.25
Design load, lb @ - camber ----- 1360 @ .352
Deflection rate, lb per inch, @ design load
@ Spring ----- 140
@ Wheel (wheel rate) ----- 123
Spring liners
Number ----- 7
Location ----- Between all leaves except numbers 6 and 7
Material ----- Polyethylene with graphite

REAR SUSPENSION
CONTINUED ON PAGE 6

SHOCK ABSORBER
 Type ----- Direct, double acting, hydraulic,
 freon filled envelope in reservoir
 Piston diameter ----- 1.00

STRUT
 Material ----- Forged steel
 Diameter ----- .75

REAR WHEEL ALIGNMENT

Design ----- N2 to N1
 Camber (degrees) ----- 1/16
 Toe-in, per wheel -----
 Curb
 Camber (degrees) ----- N5/6 to P1/6
 Toe, total ----- 0 to 1/8 toe in

STABILIZER BAR (427 V-8)
 Diameter ----- .562

REAR AXLE

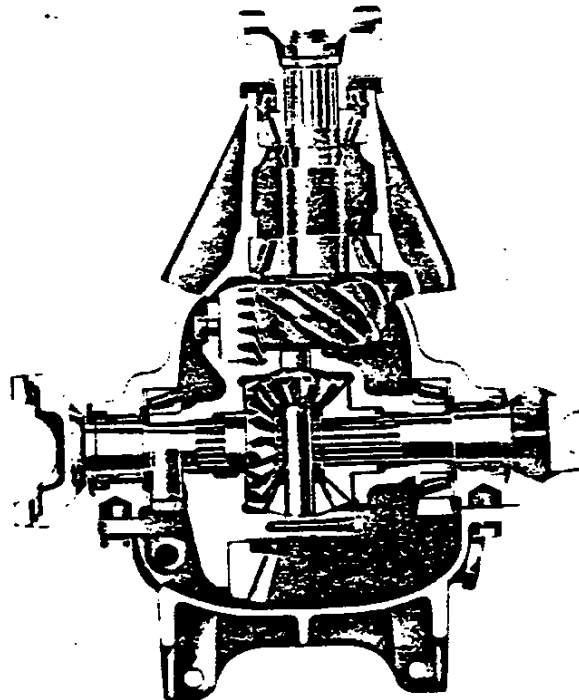

DIFFERENTIAL CARRIER

GENERAL
 Description ----- Semi-floating
 Lubricant -----
 Type --- For standard axles, Military MIL-L-2105-B
 Capacity (pts) ----- 3.7
 Filler plug ----- 1-3/8 hex, 1-20 AN thread
 Viscosity ----- SAE 80
 Regular production ratio ----- 3.36:1
 Differential carrier
 Type ----- Hypoid gear with
 overhung pinion gear supported
 by two taper roller bearings

Offset ----- 1.3
 Hypoid gear PD ----- 8.375
 Pinion bearing adjustment ----- Shim
 Cover assemblage ----- Bolted to
 differential carrier

DIFFERENTIAL
 Type ----- Two pinion in cast
 nodular iron case

HYPOID AND PINION GEAR TOOTH COMBINATION	
3.08 -----	37, 12
3.36 -----	37, 11
3.55 -----	32, 9
3.70 -----	37, 10
4.11 -----	37, 9
4.56 -----	41, 9

POSITRACTION DIFFERENTIAL (For availability, see POWER TRAINS)
 Type ----- Two pinion with dual disc clutches

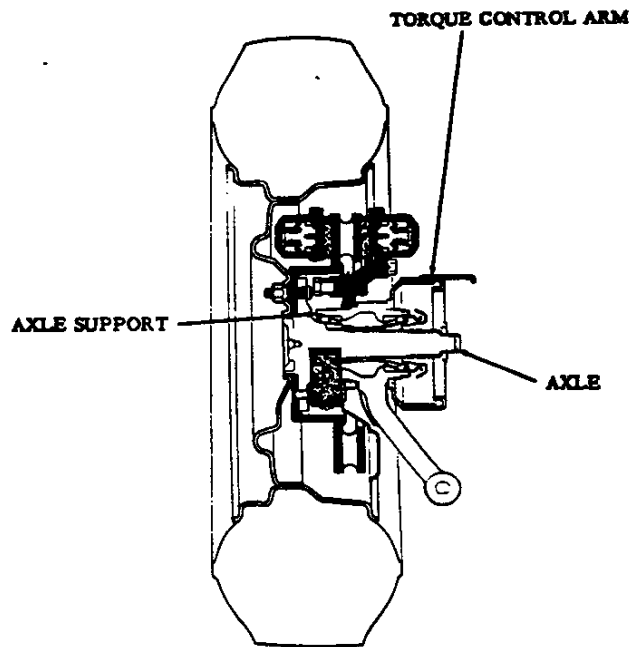

REAR WHEEL AND AXLE

GENERAL

Description ----- Brake disc flange integral with axle which is universally-jointed (thru splined axle flange) to axle shaft; torque control arm bolted to axle support. Axle supported by two taper roller bearings.

AXLE

Material ----- Steel forging, heat treated
 Diameter at outer bearing -----1.3743-1.3748
 Diameter at inner bearing -----1.1868-1.1873

AXLE SHAFT

Type ----- Welded steel tubing incorporating universal joint at each end

AXLE BEARINGS

Type ----- Taper roller
 Quantity ----- 2 per wheel
 Bearing seals
 Description, outer and inner----Steel encased rubber

AXLE FLANGE

Material ----- Cast nodular iron

AXLE SUPPORT

Material ----- Cast nodular iron

TORQUE CONTROL ARM

Description ----- Welded steel box section

BRAKES

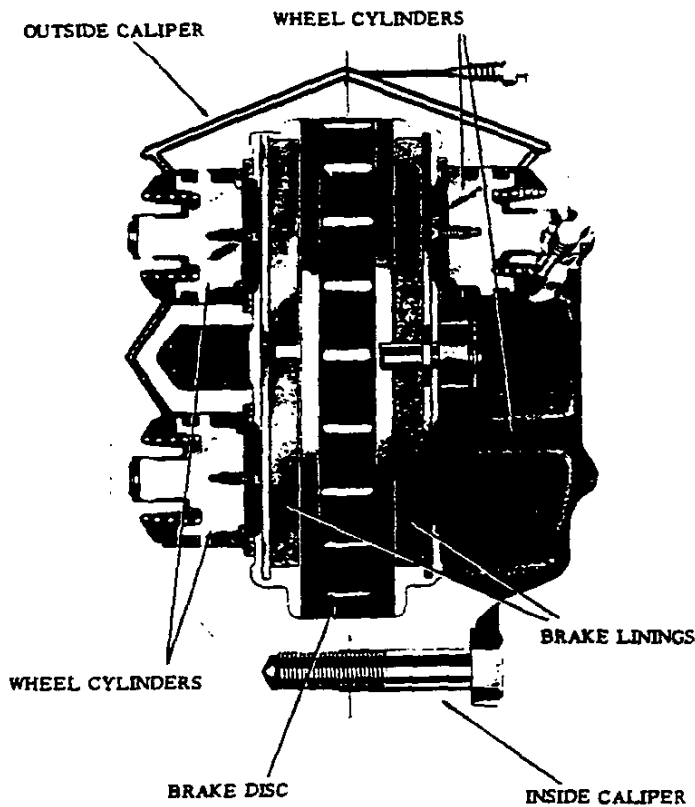

PARKING BRAKE

Type ----- Mechanical, internal
 (separate from rear service brakes);
 operates on rear wheels.
 Control ----- T handle in passenger compartment
 Drum diameter ----- 6.5
 Brake lining
 Number ----- 2 shoes per each rear wheel
 Size (L x W x T) ----- 6.77 x 1.25 x .175

STOPLIGHT SWITCH

Type ----- Electrical: make-break, normally on
 Location ----- On dash panel brace

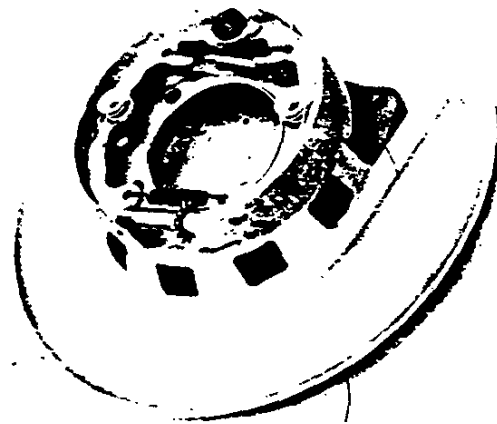

PARKING BRAKE

SERVICE BRAKES, Regular Production

General

Type ----- Caliper disc, 4-wheel hydraulic
 Line pressure, psi, @ 100 lb pedal load ----- 550
 Braking ratios
 Pedal ----- 4.60
 Hydraulic ----- 43.3
 ● Overall ----- 199.2
 Distribution of braking effort, front, percent ----- 65.0
 Brake disc
 Construction ----- Caliper type with radial
 cavities for heat dissipation
 Material ----- Cast iron
 Diameter, front and rear ----- 11.75
 Swept drum area, sq. inches ----- 461.2
 Brake lining
 Material ----- Woven asbestos
 Size, all segments (L x W x T) ----- 5.96 x 2.21 x .41
 ● Method of attachment ----- Riveted
 Total effective area, sq. inches ----- 78.1
 Gross lining area, sq. inches ----- 86.3
 Master cylinder
 Piston diameter ----- 1.00
 Piston travel (with available pedal travel) ----- 1.10
 Wheel cylinders
 Number ----- 4 per wheel
 Piston diameter
 Front ----- 1.875
 Rear ----- 1.375
 Foot pedal travel ----- 5.00

POWER BRAKES, RPO J50 (Same as SERVICE BRAKES, Regular Production, except as follows)

General

Type ----- Vacuum power unit
 added to assist master cylinder
 Braking ratios
 Pedal ----- 3.41
 Hydraulic ----- 43.3
 Overall ----- 147.7
 Master cylinder
 Type ----- Divided output
 Piston travel (with foot pedal) ----- 1.20
 Foot pedal travel ----- 4.12

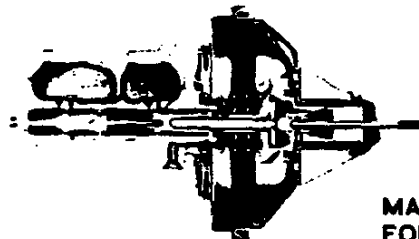

MASTER CYLINDER
 FOR RPO J50

WHEELS AND TIRES

WHEELS, Regular Production

Type ----- Short spoke spider
 Attachment to hub ----- 5 hex nuts, 7/16-20 UNF-2B,
 arranged on a 4.75 diameter bolt circle
 Offset ----- .44
 Rim size-----15 x 5.5K

WHEEL, RPO 2-P48

Type ----- Quick take-off
 Material ----- Cast aluminum
 Rim size ----- 15 x 6L
 Offset ----- .61
 Method of retention ----- Adapter
 and lock nut (2-5/8 - 8 UN 2B)

TIRES, Regular Production

Type ----- Rayon tubeless, blackwall
 Construction ----- 4 ply
 Size and ply rating ----- 7.75 x 15-4 PR
 Specifications
 Loaded rolling radius ----- 12.6
 Loaded rev/mi @ 50 MPH ----- 776
 Capacity (lb @ psi) ----- 1270 @ 24
 Recommend inflation, all tires, psi ----- 24

SPARE TIRE

Location ----- Under gasoline tank, accessible
 from underside of vehicle, shielded with cover.

BULBS, FUSES, AND CIRCUIT BREAKERS

LAMPS		NO. REQUIRED AND TRADE NO.	CANDLE POWER PER LAMP
Air conditioning		1-1893	2
Back up		2-1156	32
Cigarette lighter		1-1445	1
Clock		2-1816	3
Courtesy			
Instrument panel		2-90	6
Rear compartment		1-90	6
Direction signal indicator		2-1816	3
Dome		1-90	6
Glove compartment		1-1893	2
Headlamp	Outer	2-4002	High beam, 37.5W Low beam, 55.0W
	Inner	2-4001	High beam, 37.5W

BULBS, FUSES AND CIRCUIT
BREAKERS CONTINUED ON

BULBS, FUSES, AND CIRCUIT BREAKERS

Headlamp hi-beam indicator	1-1445	1
Headlamp warning indicator	1-257	2
Heater	1-1893	2
Ignition switch	1-1445	1
Instrument cluster	9-1816	3
License plate rear	1-1155	4
Parking		
Park	2-1157	4
Turn		32
Parking brake alarm	1-257	2
Radio	1-1893	2
Spot lamp, portable	1-4416	30W
Tail		
Tail	4-1157	4
Stop and turn		32

CIRCUIT	TYPE OF PROTECTION	LOCATION AND CIRCUIT*
Air conditioning	AGC 30 fuse	In line
Air conditioning lamp	AGC 30 fuse	Fuse panel (f)
Air conditioning lamp	AGC 4 fuse	Fuse panel (d)
Backup lamps	AGC 10 fuse	Fuse panel (b)
Cigarette lighter	AGC 15 fuse	Fuse panel (c)
Cigarette lighter lamp	AGC 4 fuse	Fuse panel (d)
Clock	AGC 15 fuse	Fuse panel (c)
Clock lamps	AGC 4 fuse	Fuse panel (d)
Courtesy lamps	AGC 15 fuse	Fuse panel (c)
Dome lamp	AGC 15 fuse	Fuse panel (c)
Fuel gage	AGC 10 fuse	Fuse panel (g)
Glove compartment lamp	AGC 15 fuse	Fuse panel (c)
Headlamp hi-beam indicator lamp	15 amp CB	Light switch
Headlamp motors	50 amp CB	Hinge pillar
Headlamp warning indicator lamp	40 amp CB	Hinge pillar
Headlamps	15 amp CB	Light switch
Heater	AGC 10 fuse	Fuse panel (f)
Heater lamp	AGC 4 fuse	Fuse panel (d)
Ignition switch lamp	AGC 4 fuse	Fuse panel (d)
Instrument cluster lamps	AGC 4 fuse	Fuse panel (d)
License plate, rear	AGC 10 fuse	Fuse panel (b)
Parking brake alarm lamp	AGC 10 fuse	Fuse panel (g)
Parking lamps	15 amp CB	Light switch
Power windows	40 amp CB	Hinge pillar
Radio and radio lamp	AGC 2.5 fuse	Fuse panel (e)
Radio antenna	AGC 15 fuse	Fuse panel (c)
Rear compartment vent motor	AGC 10 fuse	Fuse panel (f)
Stop lamps	AGC 15 fuse	Fuse panel (c)
Tail lamps	AGC 10 fuse	Fuse panel (b)
Temperature gage	AGC 10 fuse	Fuse panel (g)
Windshield wiper	14 amp CB	Switch
Spot lamp, portable	AGC 15 fuse	Fuse panel (c)

* Letter suffix indicates same circuit.

POWER TRAINS

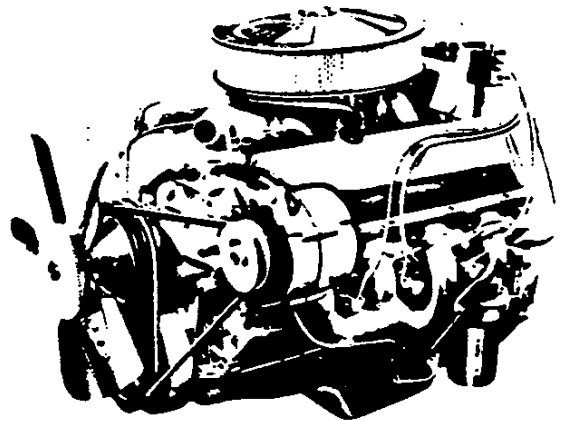

POWER TEAM COMBINATIONS	2
ENGINE DATA AND RATINGS	3
ENGINE SPEED AND PISTON TRAVEL	3
VEHICLE PERFORMANCE FACTORS	4
ENGINE OUTPUT CURVES	5
PRINCIPAL COMPONENTS	6
FUEL SYSTEM	11
EXHAUST AND VENTILATION SYSTEM	11
LUBRICATION SYSTEM	12
COOLING SYSTEM	13
ELECTRICAL SYSTEM	14
CLUTCHES	15
THREE AND FOUR SPEED TRANSMISSIONS	15
POWERGLIDE	16

POWER TEAM COMBINATIONS

● AXLE RATIO **

ENGINE	EQUIPMENT	TRANSMISSION	General Purpose Standard	● AXLE RATIO **			Air Conditioning
				Mountain	Economy Cruise	Special Purpose	
300 HP ENGINE 327 CUBIC INCH V-8 STANDARD	FOUR-BARREL CARBURETOR HYDRAULIC LIFTERS	3-SPEED (2.54:1 low)	3.36:1				3.36:1
		4-SPEED (2.52:1 low)	3.36:1		3.08:1*		3.36:1
		POWERGLIDE	3.36:1				3.36:1
350 HP ENGINE 327 CUBIC INCH V-8 RPO - L79	4-BARREL CARB. HIGH LIFT CAM HYDRAULIC LIFTERS	4-SPEED (2.52:1 low)	3.36:1	3.55:1*			3.36:1
		4-SPEED (2.20:1 low)	3.70:1	4.11:1*			
390 HP ENGINE 427 CUBIC INCH V-8 RPO - L36	4-BARREL CARB. SPECIAL CAMSHAFT HYDRAULIC LIFTERS	4-SPEED (2.52:1 low)	3.08:1*	3.36:1*			
		4-SPEED (2.20:1 low)	3.36:1*	3.55:1*	3.08:1*	3.70:1*	
425 HP ENGINE 427 CUBIC INCH V-8 RPO - L72	4-BARREL SPECIAL CAMSHAFT MECHANICAL LIFTERS	4-SPEED (2.20:1 low)	3.55:1*	3.70:1*	3.36:1*	4.11:1*	

* - AVAILABLE AS POSITRACTION AXLE ONLY.

** - POSITRACTION AXLE RATIOS AVAILABLE IN COMBINATIONS SHOWN.

MULTIPLICATION FACTORS

WITH MANUAL TRANSMISSIONS

ENGINE	CARBURETION	TRANSMISSION	TOTAL GEAR REDUCTION					AXLE RATIO
			1st	2nd	3rd	4th	Rev	
300 HP Standard	4-Barrel	3-Speed (2.54:1)	8.53	5.04	3.36		8.84	3.36
		4-Speed (2.52:1)	8.47	6.32	4.90	3.36	8.70	
350 HP RPO-L79	4-Barrel	4-Speed (2.52:1)	8.47	6.32	4.90	3.36	8.70	3.36
		4-Speed (2.20:1)	8.14	6.07	4.70	3.70	8.36	3.70
390 HP RPO L36	4-Barrel	4-Speed (2.52:1)	7.76	5.79	4.50	3.08	7.98	3.08
		4-Speed (2.20:1)	7.39	5.51	4.27	3.36	7.59	3.36
425 HP RPO L72	4-Barrel	4-Speed (2.20:1)	7.81	5.82	4.51	3.55	8.02	3.55

WITH AUTOMATIC TRANSMISSIONS

ENGINE	TRANSMISSION	SELECTOR POSITION	TOTAL TORQUE MULTIPLICATION*	AXLE RATIO
300 HP - Standard	Powerglide	Drive	12.43:1 - 3.36:1	3.36:1
		Low & Reverse	12.43:1 - 5.91:1	

* - Axle ratio x transmission ratio.

ENGINE DATA AND RATINGS

● GENERAL DATA

		V-8 OHV			
Engine Type		327		427	
Piston Displacement (Cu. In.)		Standard	RPO-L79	RPO-L36	RPO-L72
Availability		Eight			
Number Cylinders		4.00 x 3.25		4.251 x 3.76	
Bore and Stroke (nominal)		10.25:1	11.0:1	10.25:1	11.0:1
Compression Ratio		51.2		57.8	
Taxable (SAE) Horsepower		1-8-4-3-6-5-7-2			
Firing Order		500	700	550	800
Idling Speed (RPM)		160		160	170
Compression Press. (PSI) @ Cranking Speed, Engine Hot		Full Pressure			
Lubrication		Two front and one rear, compression type			
Power Plant Mounting		30.52		29.43	
Measurements	Fan to rear of engine block	27.28		26.48	30.96
	Top air cleaner to bottom oil pan	28.54		32.30	
	Exhaust manifold to generator (width)				

● ADVERTISED ENGINE RATING

Engine	300 HP - 327 Cu. In.	350 HP - 327 Cu. In.	390 HP - 427 Cu. In.	425 HP - 427 Cu. In.	
Availability	Standard	RPO-L79	RPO-L36	RPO-L72	
Brake HP	Gross	300 @ 5000	350 @ 5800	390 @ 5200	425 @ 5600
	Net	235 @ 4800			
Torque (lb-ft)	Gross	360 @ 3400	360 @ 3600	460 @ 3600	460 @ 4000
	Net	320 @ 3000			

ENGINE SPEED AND PISTON TRAVEL

Transmission	327 Cu. In.				427 Cu. In.			
	3-Speed (a)	4-Speed		Pwr/gld.(a)	4-Speed			
Rear Axle Ratio	3.36:1	3.36:1	3.70:1 (b)	3.36:1	3.08:1 (c)	3.36:1 (d)	3.55:1 (e)	
Tire Size	7.75 x 15-4PR							
Crankshaft Revolutions per Mile	2553.6		2812.0	2553.6	2340.8	2553.6	2698.0	
Crankshaft RPM @ MPH	Low	108.1	107.3	103.1	74.9	98.3	93.6	98.9
	Second	63.8	62.0	76.9		73.3	69.8	73.7
	Third	42.6	62.1	59.5	42.6	57.0	54.5	57.1
	Fourth		42.6	46.9		39.0	42.6	45.0
	Reverse	111.9	110.2	105.9	74.9	101.0	96.2	101.6
Piston Travel (Ft/Mile)	1383.2		1523.2	1383.2	1466.9	1600.3	1690.7	

- (a) Available only with 300 HP engine.
- (b) Standard ratio for 350 HP engine with 2.20:1 low transmission.
- (c) Standard ratio for 390 HP engine with 2.52:1 low transmission.
- (d) Standard ratio for 390 HP engine with 2.20:1 low transmission.
- (e) Standard ratio for 425 HP engine with 2.20:1 low transmission.

VEHICLE PERFORMANCE FACTORS

ENGINE	327 Cu. In. 275 HP Standard	327 Cu. In. 350 HP RPO L79	427 Cu. In. 390 HP RPO L36	427 Cu. In. 425 HP RPO L72
--------	-----------------------------------	----------------------------------	----------------------------------	----------------------------------

3-SPEED TRANSMISSION

Performance Weight (pounds)	3443	3446		
Pounds per Gross Horsepower	11.48	9.84		
Pounds per Cu. In. Displacement	10.53	10.54		
Gross HP per Cu. In. Displacement	.917	1.070		
Power Displacement (cu. ft./mile)	241.62	241.62		
Displacement Factor (cu. ft./ton mile)	140.39	140.23		

4-SPEED TRANSMISSION

Performance Weight (pounds)	3436	3440	3612	3614
Pounds per Gross Horsepower	11.45	9.83	9.26	8.50
Pounds per Cu. In. Displacement	10.51	10.52	8.46	8.46
Gross HP per Cu. In. Displacement	.917	1.070	.913	.995
Power Displacement (cu. ft./mile)	241.62	241.62	289.21	333.34
Displacement Factor (cu. ft./ton mile)	140.64	142.13	160.14	184.47

POWERGLIDE*

Performance Weight (pounds)	3455			
Pounds per Gross Horsepower	11.52			
Pounds per Cu. In. Displacement	10.57			
Gross HP per Cu. In. Displacement	.917			
Power Displacement (cu. ft./mile)	241.62			
Displacement Factor (cu. ft./ton mile)	139.91			

* - Data computed assuming zero slippage in torque converter.

GLOSSARY

Performance Weight	Curb Weight plus 600 Lb (weight of four 150 lb passengers)
Power Displacement	$\frac{\text{Crankshaft Revs/Mi} \times \text{Piston Displacement}}{2 \times 1728}$
Displacement Factor	$\frac{\text{Power Displacement}}{\text{Performance Wt (tons)}}$

ENGINE OUTPUT CURVES

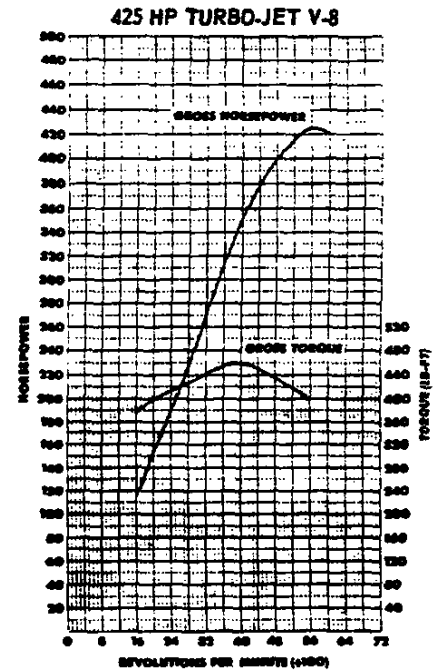
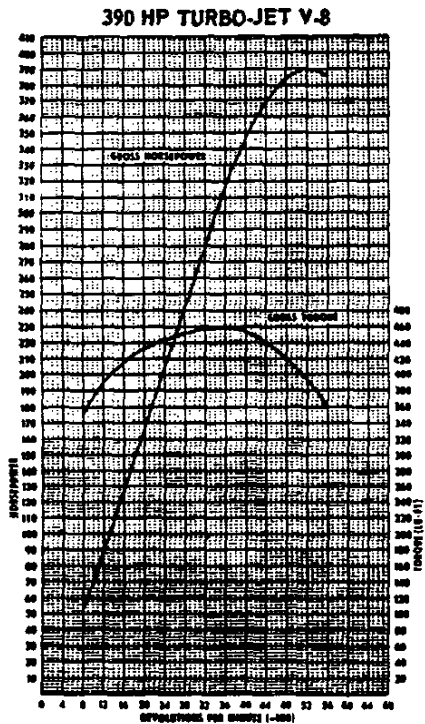
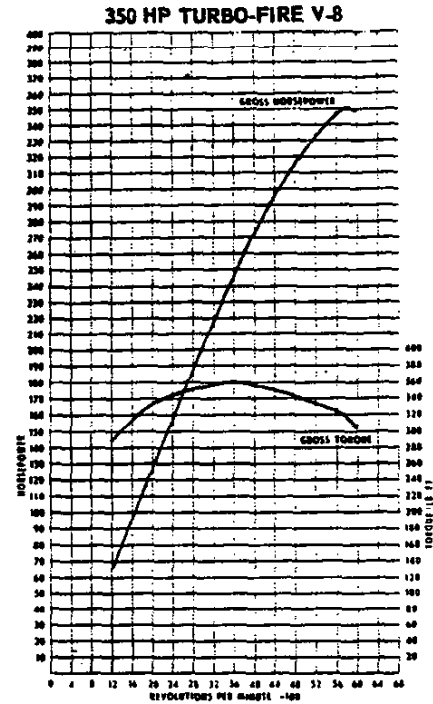
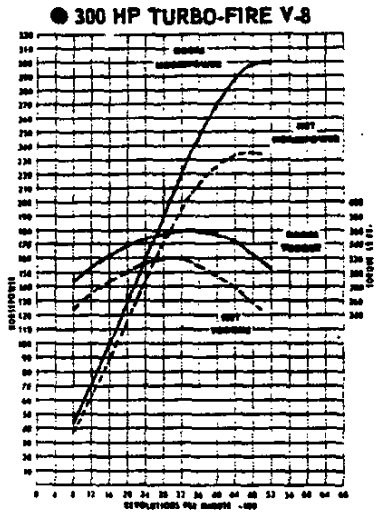

The engine output curves represent full throttle performance as obtained from dynamometer test data corrected to standard barometric pressure 29.92 inches of mercury and standard temperature of 60 degrees F.

GROSS POWER and TORQUE were obtained in a regular dynamometer test with the dynamometer exhaust system,

no fan, generator not charging, optimum spark advance, and optimum fuel setting.

NET POWER and TORQUE were obtained from a dynamometer test simulating actual operating conditions when the engine is in its vehicle, except the generator is not charging.

PRINCIPAL COMPONENTS

CYLINDER BLOCK

Material	Cast alloy iron
Bore Diameter	
V8-327 Cu.In.	3.9995-4.0025
V8-427 Cu.In.	4.2495-4.2525
Bore Spacing (Centerline to Centerline)	
V8-327 Cu.In.	4.4
V8-427 Cu.In.	4.84
Number of Bulkheads	5
Water Jacket	Full length around each cylinder
Cylinder Numbering Arrangement (Front to Rear)	
Left Bank	1-3-5-7
Right Bank	2-4-6-8

CYLINDER HEAD

Material	High chrome cast alloy iron
Bolt Number	34 (327 Cu.In.); 32 (427 Cu.In.)
Bolt Size4375 dia.; 14 threads/inch

COMBUSTION CHAMBER VOLUME

(Total chamber volume of assembled engine with piston at top center)	
V8-327 Cu.In. (Base)	4.49 Cu.In.
V8-327 Cu.In. (RPO L79)	3.97 Cu.In.
V8-427 Cu.In. (RPO L36)	5.90 Cu.In.
V8-427 Cu.In. (RPO L72)	4.92 Cu.In.

INLET MANIFOLD

Material	
V8-327 (Base) & V8-427 (RPO L36) ---	Cast alloy iron
V8-327 (RPO L79) & V8-427 (RPO L72)	Cast aluminum alloy
Heat Provision	Exhaust gas crossover at carburetor mounting pad

EXHAUST MANIFOLD

Material	Cast alloy iron
Type	
V8-327 Cu.In. ---	Dual, 4 port, exhaust emission to a single runner with center takedown collector
V8-427 Cu.In.	Dual, 4 port, extended runners from each port converging to a rear takedown collector
Outlet Diameter (Nominal)	2.50

CRANKSHAFT

Material	Forged steel
End Play006-.010
Counter Weights	6
Crank Arm Length	
V8-327 Cu.In.	1.625
V8-427 Cu.In.	1.88
Torsional Damper	Rubber mounted inertia
Timing Gear	Steel; sprocket & chain
Pulley Pitch Diameter	6.64

CRANKSHAFTS AND BEARINGS 327 CUBIC INCH V-8 ENGINE

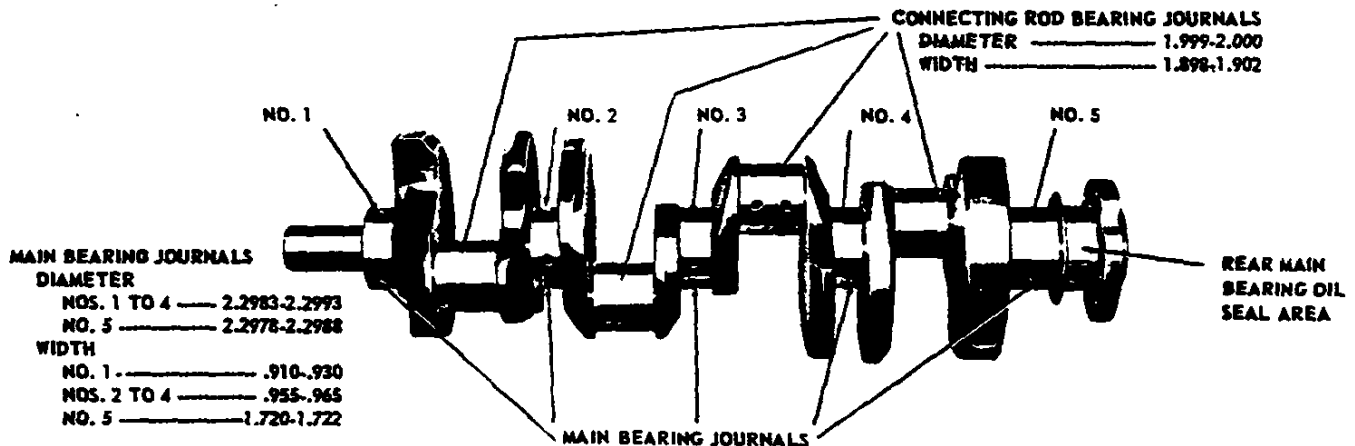

MAIN BEARINGS

Material ----- Premium aluminum except No. 5
 upper sintered copper nickel backed babbitt
 Type ----- Precision removable
 Thrust Against Bearing No. ----- 5
 Clearance
 V8-327 Cu.In. ----- (#1-4) .0008-.0034;
 (#5) .0010-.0036
 V8-427 Cu.In. ----- (#1-4) .0013-.0029;
 (#5) .0017-.0033

Dimensions	Theoretical Inner Dia.	Effective Length	Projected Area
V8-327 Cu.In.			
Bearing #1	2.3013	.752	1.7306
Bearing #2-4	2.3009	.752	1.7303
Bearing #5	2.3006	1.1824	2.7202
V8-427 Cu.In. (RPO L36)			
Bearing #1-2	2.7507	.992	2.7287
Bearing #3-4	2.7501	.992	2.7281
Bearing #5	2.7504	1.2525	3.4449
V8-427 Cu.In. (RPO L72)			
Bearing #1-4	2.7508	.992	2.7288
Bearing #5	2.7508	1.2525	3.4446

CAMSHAFT

Material ----- Cast alloy iron
 Drive ----- Sprocket & chain; steel
 Lobe Lift
 V8-327 Cu.In. (Base) ----- .2658 Inlet & Exhaust
 V8-327 Cu.In. (RPO L79) ----- .2981 Inlet & Exhaust
 V8-427 Cu.In. (RPO L36) ----- .2714 Inlet;
 .2824 Exhaust
 V8-427 Cu.In. (RPO L72) ----- .3057 Inlet & Exhaust
 Bearings ----- 5; steel backed babbitt

VALVE TRAIN

Type ----- Individually mounted overhead
 rocker arms, push rod actuated
 Lifters ----- Hydraulic
 V8-427 Cu.In. (RPO L72) - Mechanical
 Push Rods
 Type ----- Hollow steel
 Ends
 V8-327 Cu.In. (Base) ----- Hardened
 V8-327 Cu.In. (RPO L79) ----- Hardened steel
 insert on rocker arm ends
 V8-427 Cu.In. ----- Carburized steel inserts
 Rocker Arms
 Material ----- Stamped steel
 Ratio
 V8-327 Cu.In. ----- 1.50:1
 V8-427 Cu.In. ----- 1.70:1

VALVE SPRINGS

Diameter (I.D.)
 V8-327 Cu.In. ----- .872-.888
 V8-427 Cu.In. ----- 1.082-1.098
 Installed Length (In. @ Lb.)
 Valves Closed
 V8-327 Cu.In. ----- 1.66 @ 78-86
 V8-427 Cu.In. ----- 1.88 @ 94-106
 Valves Opened
 V8-327 Cu.In. ----- 1.26 @ 170-180
 V8-427 Cu.In. ----- 1.38 @ 303-327
 Free Length
 V8-327 Cu.In. ----- 2.08
 V8-427 Cu.In. ----- 2.09
 Valve Spring Damper
 V8-327 Cu.In. ----- Flat steel, 4 coils
 V8-427 Cu.In. ----- Flat steel, 3.62 coils

**CAMSHAFT AND BEARINGS
 327 CUBIC INCH V-8 ENGINE**

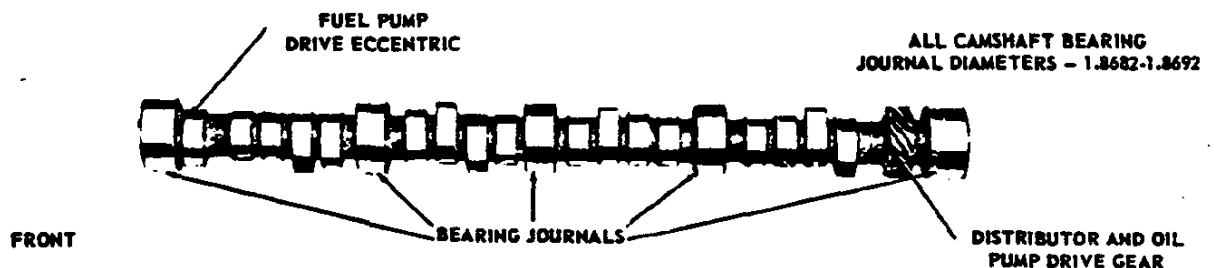

PRINCIPAL COMPONENTS

VALVES-INLET

Material ----- Alloy steel
 Coating -----
 V8-327 Cu.In. ----- None
 V8-427 Cu.In. ----- Face & head
 aluminized; chrome flash stem on RPO L72
 Valve Guide Inserts (V8-427) ----- Cast alloy iron

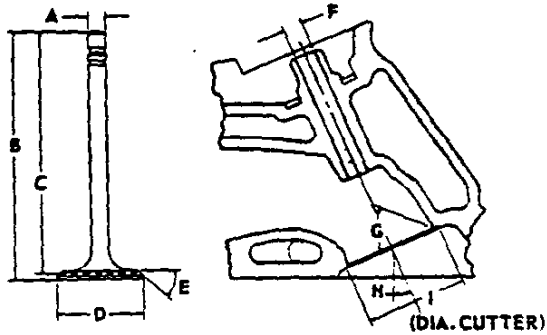

VALVES-EXHAUST

Material ----- High alloy steel
 Coating -----
 V8-327 Cu.In. ----- Aluminum face
 V8-427 Cu.In. ----- Face & head
 aluminized; chrome flash stem on RPO L72

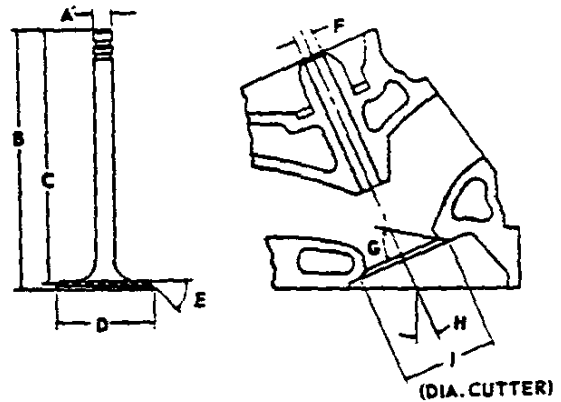

A - Stem Diameter	
V8-327 Cu.In. -----	.3410-.3417
V8-427 Cu.In. -----	.3715-.3722
B - Overall Length	
V8-327 Cu.In. -----	4.870-4.889
V8-427 Cu.In. (RPO L36) -----	5.215-5.235
V8-427 Cu.In. (RPO L72) -----	5.204-5.224
C - Gage Length	
V8-327 Cu.In. -----	4.785-4.795
V8-427 Cu.In. -----	5.115-5.125
D - Overall Head Diameter	
V8-327 Cu.In. (Base) -----	1.935-1.945
V8-327 Cu.In. (RPO L79) -----	2.017-2.023
V8-427 Cu.In. (RPO L36) -----	2.060-2.070
V8-427 Cu.In. (RPO L72) -----	2.185-2.195
E - Angle of Face ----- 45°	
F - Guide Diameter	
V8-327 Cu.In. -----	.3427-.3437
V8-427 Cu.In. -----	.3732-.3437
G - Angle of Seat ----- 46°	
H - Valve Angle	
V8-327 Cu.In. -----	23°
V8-427 Cu.In. -----	4°
I - Valve Seat (Cutter) Diameter	
V8-327 Cu.In. (Base) -----	1.990-2.010
V8-327 Cu.In. (RPO L79) -----	2.020
V8-427 Cu.In. -----	2.580

A - Stem Diameter	
V8-327 Cu.In. -----	.3410-.3417
V8-427 Cu.In. -----	.3713-.3720
B - Overall Length	
V8-327 Cu.In. (Base) -----	4.913-4.933
V8-327 Cu.In. (RPO L79) -----	4.891-4.910
V8-427 Cu.In. -----	5.345-5.365
C - Gage Length	
V8-327 Cu.In. -----	4.781-4.791
V8-427 Cu.In. -----	5.235-5.245
D - Overall Head Diameter	
V8-327 Cu.In. (Base) -----	1.495-1.505
V8-327 Cu.In. (RPO L79) -----	1.595-1.605
V8-427 Cu.In. -----	1.715-1.725
E - Angle of Face ----- 45°	
F - Guide Diameter	
V8-327 Cu.In. -----	.3427-.3437
V8-427 Cu.In. -----	.3732-.3742
G - Angle of Seat ----- 46°	
H - Valve Angle	
V8-327 Cu.In. -----	23°
V8-427 Cu.In. -----	4°
I - Valve Seat (Cutter) Diameter	
V8-327 Cu.In. (Base) -----	1.550-1.570
V8-327 Cu.In. (RPO L79) -----	1.610
V8-427 Cu.In. -----	2.120

PISTONS

Material	
V8-327 Cu.In. (Base) -----	Cast aluminum alloy
V8-327 Cu.In. (RPO L79) --	Aluminum impact extruded
V8-427 Cu.In. (RPO L36) -----	Cast aluminum alloy
V8-427 Cu.In. (RPO L72) -	Aluminum impact extruded
Head Type	
V8-327 Cu.In. (Base) -----	Flat, notched
V8-327 Cu.In. (RPO L79) -----	Domed
V8-427 Cu.In. -----	Domed
Skirt Type ----- Slipper	
Top Land Clearance	
V8-327 Cu.In. (Base) -----	.0365-.0455
V8-327 Cu.In. (RPO L79) -----	.0395-.0425
V8-427 Cu.In. (RPO L36) -----	.0305-.0375
V8-427 Cu.In. (RPO L72) -----	.0265-.0335
Skirt Clearance	
V8-327 Cu.In. (Base) -----	.0005-.0011
V8-327 Cu.In. (RPO L79) -----	.0039-.0045
V8-427 Cu.In. (RPO L36) -----	.0009-.0015
V8-427 Cu.In. (RPO L72) -----	.0037-.0043
Compression Ring Groove Depth	
V8-327 Cu.In. -----	.2217-.2283
V8-427 Cu.In. -----	.2348-.2413
Oil Ring Groove Depth	
V8-327 Cu.In. -----	.2038-.2103
V8-427 Cu.In. (RPO L36) -----	.2183-.2248
V8-427 Cu.In. (RPO L72) -----	.2133-.2148
Pin Bore Offset	
V8-327 (Base) & V8-427 (RPO L36) -----	.055-.065
V8-327 (RPO L79) & V8-427 (RPO L72) -----	On center
Compression Height	
V8-327 Cu.In. (Base) -----	1.674-1.676
V8-327 Cu.In. (RPO L79) -----	1.673-1.677
V8-427 Cu.In. (RPO L36) -----	1.908-1.912
V8-427 Cu.In. (RPO L72) -----	1.768-1.772

PISTON PINS

Material -----	Chromium steel
Length	
V8-327 Cu.In. -----	2.990-3.010
V8-427 Cu.In. -----	2.930-2.950
Diameter	
V8-327 Cu.In. -----	.9270-.9273
V8-427 Cu.In. -----	.9895-.9898
Clearance in Piston	
V8-327 Cu.In. (Base) -----	.00015-.00025
V8-327 Cu.In. (RPO L79) -----	.00045-.00055
V8-427 Cu.In. (RPO L36) -----	.00025-.00035
V8-427 Cu.In. (RPO L72) -----	.00030-.00040
Pin Mounting -----	Locked in rod by shrink fit

VALVE LIFT

V8-327 Cu.In. (Base) -----	.3987 Inlet & Exhaust
V8-327 Cu.In. (RPO L79) -----	.4472 Inlet & Exhaust
V8-427 Cu.In. (RPO L36) -----	.4614 Inlet; .4800 Exhaust
V8-427 Cu.In. (RPO L72) -----	.5197 Inlet & Exhaust

VALVE TIMING (Crankshaft Degrees)

V8-327 Cu.In. - Base	Excluding Ramps	Including Ramps
Inlet Valve (Zero lash)		
Opens - BTC	12°30'	32°30'
Closes - ABC	57°30'	87°30'
Duration	250°	300°
Exhaust Valve (Zero lash)		
Opens - BBC	54°30'	74°30'
Closes - ATC	15°30'	45°30'
Duration	250°	300°

V8-327 Cu.In. - RPO L79	Excluding Ramps	Including Ramps
Inlet Valve (Zero lash)		
Opens - BTC	40°	54°
Closes - ABC	86°	108°
Duration	306°	342°
Exhaust Valve (Zero lash)		
Opens - BBC	88°	102°
Closes - ATC	38°	60°
Duration	306°	342°

V8-427 Cu.In. - RPO L36	Excluding Ramps	Including Ramps
Inlet Valve (Zero lash)		
Opens - BTC	40°	56°
Closes - ABC	80°	114°
Duration	300°	350°
Exhaust Valve (Zero lash)		
Opens - BBC	88°	110°
Closes - ATC	32°	62°
Duration	300°	352°

V8-427 Cu.In. - RPO L72	Including Ramps
Inlet Valve (opens with .024 lash)	
Opens - BTC	54°
Closes - ABC	102°
Duration	336°
Exhaust Valve (closes with .028 lash)	
Opens - BBC	102°
Closes - ATC	54°
Duration	336°

PRINCIPAL COMPONENTS—Cont'd.

COMPRESSION RING - UPPER

Material	Cast alloy iron
Type	Inside bevel (bottom of ring 30 degrees to piston vertical axis)
Face	
V8-327 Cu.In. (Base)	Tapered edge
V8-327 Cu.In. (RPO L79)	Straight edge
●V8-427 Cu.In.	Barrel edge
Coating	
V8-327 Cu.In. (Base)	Chrome plate
V8-327 Cu.In. (RPO L79)	Molybdenum inlay
V8-427 Cu.In.	Molybdenum inlay
Width	
V8-327 Cu.In. (Base)	.0775-.0780
V8-327 Cu.In. (RPO L79)	.0770-.0775
V8-427 Cu.In.	.0770-.0775
Wall Thickness	
V8-327 Cu.In.	.190-.200
V8-427 Cu.In.	.202-.212
Gap	
V8-327 Cu.In. (Base)	.013-.023
V8-327 Cu.In. (RPO L79)	.013-.025
V8-427 Cu.In.	.010-.020

COMPRESSION RINGS - LOWER

Material	Cast alloy iron
Type	Inside bevel (top of ring 50 degrees to piston vertical axis V8-327 and 28-52 degrees for V8-427)
Face	Tapered
Coating	
V8-327 Cu.In. (Base)	Wear resistant
V8-327 Cu.In. (RPO L79)	Chrome plate
V8-427 Cu.In. (RPO L36)	Wear resistant
V8-427 Cu.In. (RPO L72)	Chrome plate
Width	
V8-327 Cu.In.	.0770-.0775
V8-427 Cu.In.	.0770-.0775
Wall Thickness	
V8-327 Cu.In. (Base)	.164-.170
V8-327 Cu.In. (RPO L79)	.190-.200
V8-427 Cu.In.	.202-.212
Gap	
V8-327 Cu.In.	.013-.025
V8-427 Cu.In.	.010-.020
Expander (Used with V8-327 Cu.In. Base Only)	
Material	Steel
Width	.068-.074
Wall Thickness	.0180

OIL CONTROL RINGS

Type	Multi-piece (two rails and one spacer)
Material	
Rails	Steel
Spacer	Alloy steel
Width (assembled)	
V8-327 Cu.In.	.1840-.1880
V8-427 Cu.In.	.1830-.1880
Wall Thickness	
V8-327 Cu.In.	.150-.156
V8-427 Cu.In.	.137-.143
Gap	
V8-327 Cu.In.	.015-.055
V8-427 Cu.In.	.010-.030
Rail Coatings	Chrome plated

CONNECTING RODS

Material	Drop forged steel
V8-427 (RPO L72)	High alloy steel
Length (center to center)	
V8-327 Cu.In.	5.699-5.701
V8-427 Cu.In.	6.134-6.136

CONNECTING ROD BEARINGS

Material	Premium aluminum
Type	Precision removable
Clearance	
V8-327 Cu.In.	.0007-.0027
V8-427 Cu.In. (RPO L36)	.0009-.0025
V8-427 Cu.In. (RPO L72)	.0014-.0030
Theoretical I.D.	
V8-328 Cu.In.	2.0017
V8-427 Cu.In. (RPO L36)	2.2012
V8-427 Cu.In. (RPO L72)	2.2017
Effective Length	
V8-327 Cu.In.	.807
V8-427 Cu.In.	.857
End Play	
V8-327 Cu.In.	.009-.013
V8-427 Cu.In.	.016-.020

FUEL-EXHAUST AND VENTILATION SYSTEM

FUEL SYSTEM

FUEL TANK
 Capacity (Gal) ----- 20 (approximately)
 Location ----- In body cavity at rear of deck area
 Filler Location ----- Center of rear deck lid

FUEL FILTERS, DUAL
 In Fuel Tank ----- Mesh strainer
 Carburetor Inlet ----- Sintered bronze filter

● **FUEL PUMP**
 Type ----- Diaphragm
 Drive ----- Camshaft eccentric
 Location ----- Lower right front of engine
 Pressure Range (At Carburetor)
 V8-327 Cu.in. (Base) ----- 5.25-6.50 PSI
 V8-327 Cu.in. (RPO L79) ----- 5.00-6.50 PSI
 V8-427 Cu.in. ----- 5.50-7.00 PSI

● **AIR CLEANER**
 Type ----- Full circle intake, chrome plated
 Diameter ----- 16.78
 Filter Element ----- Oil-wetted paper

CARBURETORS

Make & Type
 V8-327 & 427 Cu.in. ----- Holley; 4-bbl. downdraft
 SAE Flange Size ----- 1.50
 Throttle Bore
 V8-327 Cu.in. (Base) --- 1.562 Primary & Secondary
 V8-327 Cu.in. (RPO L79) ----- 1.561 Primary &
 Secondary
 V8-427 Cu.in. (RPO L36) ----- 1.562 Primary &
 Secondary
 V8-427 Cu.in. (RPO L72) ----- 1.686 Primary &
 Secondary

Venturi Diameter
 V8-327 Cu.in. (Base) ----- 1.25 Primary;
 1.4375 Secondary
 V8-327 Cu.in. (RPO L79) ----- 1.25 Primary;
 1.3125 Secondary
 V8-427 Cu.in. (RPO L36) ----- 1.25 Primary;
 1.4375 Secondary
 V8-427 Cu.in. (RPO L72) ----- 1.375 Primary;
 1.4375 Secondary
 Secondary Throttle Actuation ----- By linkage
 approximately when primary valves
 are opened half between closed and open

CHOKE
 Type ----- Automatic

EXHAUST AND VENTILATION SYSTEM

EXHAUST SYSTEM
 Type ----- Dual with no resonators

MUFFLERS
 Type ----- Dual, reverse flow
 Construction ----- Heads and body joined
 by rolled lock seam construction
 Shell
 Right Hand ----- .036 stainless steel
 Left Hand ----- .036 sheet steel aluminum coating
 Wrap ----- .030 indented asbestos sheet
 Cover ----- .018 sheet steel aluminum coating
 Heads
 Right Hand ----- .048 stainless steel
 Left Hand ----- .048 sheet steel aluminum coating
 Baffles
 Right Hand ----- 4; #1 & #4, .036 stainless steel;
 #2 & #3, .036 sheet steel aluminum coating
 Left Hand ----- 4; .036 sheet steel aluminum coating
 Length, Body ----- 17.00
 Width (I.D.) ----- 9.25
 Height (I.D.) ----- 5.00

EXHAUST PIPES

Type ----- Two piece; front and rear assemblies
 Material ----- Seamless steel tubing
 Dimensions (O.D.) ----- 2.50; Powerglide 2.00
 Wall Thickness
 Front Pipes ----- .072-.092
 Rear Pipes ----- .084-.104 laminated

TAIL PIPES

Material ----- Stainless steel
 Dimensions (O.D.) ----- 2.00
 Wall Thickness ----- .023

ENGINE VENTILATION

Type ----- Closed-positive;
 fumes withdrawn into induction system from
 crankcase via hoses connecting to oil filler
 tube and fitting at base of carburetor.

● AIR INJECTION REACTOR

(California vehicles only)
 Type ----- Air injected into exhaust
 ports by crankshaft driven pump

LUBRICATION SYSTEM

GENERAL

Type	Controlled full pressure
Main Bearings	Pressure
Connecting Rods	Pressure
Piston Pins	Splash
Cylinder Walls	Pressure, jet cross sprayed
Camshaft Bearings	Pressure
Valve Lifters	Pressure
Rocker Arms	Pressure
Timing Gears	Centrifugally oiled from front camshaft bearing

Oil Pressure Sending Unit

Type	Bourdon tube
Actuation	Oil pressure

Oil Filler

Cap	Positive seal
Location	
V8-327 Cu.In.	Left front of intake manifold
V8-427 Cu.In.	Top center of right rocker cover

OIL PUMP

Type	Gear
Normal Oil Pressure	
V8-327 Cu.In.	30-45 PSI @ 1500 RPM
V8-427 Cu.In.	50-75 PSI @ 2000 RPM
Intake Type	Fixed
Capacity (GPM @ Eng. RPM)	
V8-327 Cu.In.	4.3 @ 2000
V8-427 Cu.In.	6 @ 2000
Regulator Valve	Opens between 40-45 lbs

OIL DIP STICK - LOCATION

V8-327 Cu.In.	Right side, rear of engine block
V8-427 Cu.In.	Right side, center, direct to oil pan

CRANKCASE CAPACITY (Quarts)

Refill	
V8-327 Cu.In. (Base)	4.0
V8-327 Cu.In. (RPO L79)	5.0
V8-427 Cu.In.	5.0
Refill with Filter Change	
V8-327 Cu.In. (Base)	5.0
V8-327 Cu.In. (RPO L79)	6.0
V8-427 Cu.In.	6.0

OIL FILTER

Type	Full flow, replaceable element
Location	Left rear underside of engine
Capacity	One quart
By-pass Valve	Opens between 9 to 11 PSI drop in pressure

LUBRICANT GRADES AND TEMPERATURES

32°F and Above	SAE 20W, SAE 20 or SAE 10W-30
0°F and Above	SAE 10W or SAE 10W-30
Below 0°F	SAE 5W or SAE 5W-20
Alternate	SAE 5W-30 can be used for 5W; 5W-20 or 10W-30

OIL PAN

Type of Drain Plug	Hex head
Location	Lower rear edge of oil pan sump
Size Hex Head	.860-.875
Thread	1/2-20 UNF 2A
Length	.081
Diameter	.410-.430

COOLING SYSTEM

GENERAL

Type	Liquid, pressurized
V8-327 Cu.In. (Base)	Internal by-pass
V8-327 Cu.In. (RPO L79)	External by-pass
V8-427 Cu.In.	External by-pass
Capacity (with Heater)	
V8-327 Cu.In.	19 Qts
V8-427 Cu.In.	22 Qts

RADIATOR

Type	
V8-327 Cu.In.	Aluminum, cross-flow
V8-427 Cu.In.	Copper-brass, cross-flow
Core Constant and Thickness	
Distance between Fins	
V8-327 Cu.In.	.18
V8-427 Cu.In.	.16
Distance between Tubes	.55
Thickness of Core	
V8-327 Cu.In.	2.88
V8-427 Cu.In.	2.70
Frontal Area (Sq. In.)	
V8-327 Cu.In.	315
V8-427 Cu.In.	382

SURGE TANK (327 Cu.In. Only)

Location	Right side engine compartment connected by hose to top of radiator
Capacity	2.3 Qts
Fill Requirements	Half full when weather is cold

RADIATOR CAP RELIEF VALVE

Opens at	Approximately 15 PSI
----------	----------------------

FAN

Number of Blades	3, staggered
Diameter	
V8-327 Cu.In.	17.12
V8-427 Cu.In.	17.50
Fan Pulley Pitch Diameter	7.00
Drive	
Type	Thermomodulated fluid coupling
Performance at 4000 RPM Input	At 135°-135° F fan speed 3200 to 3500 RPM; at 120° F and below, fan speed 800-1800 RPM

THERMOSTAT

Type	Pellet
Begins to Open at	177°-182° F
Fully Opened at	221° F

RADIATOR HOSE

Outlet, Lower (Radiator to Water Pump)	
V8-327 Cu.In.	1.75 I.D.
V8-427 Cu.In.	1.88 I.D.
Inlet; Upper (Thermostat Housing to Radiator)	
V8-327 Cu.In.	1.56 I.D.
V8-427 Cu.In.	1.50 I.D.

BY-PASS THERMOSTAT HOSE

V8-327 Cu.In. (RPO L79)	.725-.765 I.D.
V8-427 Cu.In.	.725-.765 I.D.

BELTS; CRANKSHAFT, FAN AND GENERATOR

Number Used	
V8-327 Cu.In. (Base)	One
V8-327 Cu.In. (RPO L79)	Two
V8-427 Cu.In.	Two
Angle of "V"	36°-42°
Pitch Line	
Fan, Generator and Water Pump Belt	
V8-327 Cu.In. (Base)	53.25
V8-327 Cu.In. (RPO L79)	54.00
V8-427 Cu.In. (RPO L36)	56.00
V8-427 Cu.In. (RPO L72)	56.20
Fan and Water Pump Belt	
V8-327 Cu.In. (RPO L79)	34.40
V8-427 Cu.In.	34.40
Width	.380

WATER PUMP

Type	Centrifugal
Capacity (GPM @ Engine RPM)	
V8-327 Cu.In.	57 @ 4400
V8-427 Cu.In.	82 @ 5200
Bearing	Permanently lubricated double row ball
Drive	Fan belt
Ratio (Pump to Engine RPM)	.949:1

DRAIN LOCATIONS AND TYPE

Radiator	Percock, left side at bottom
Engine Block	Plug; right and left center

ELECTRICAL SYSTEM

SUPPLY SYSTEM

BATTERY

Voltage 12
 Capacity (SAE) 61 amp hr @ 20 hr rate
 Total Number of Plates 66
 Number of Cells 6
 Terminal Grounded Negative
 Location Rear of left wheelhouse

GENERATOR

Type Diode rectified
 Rating
 Amps 9-37
 Volts 10-15
 Drive By fan belt
 Pulley Pitch Diameter 2.70
 Ratio (Gen to Engine Speed) 2.46:1

REGULATOR

Type Two unit; vibrator
 Voltage Regulator
 Voltage 13.8-14.8 @ 85°F
 Field Relay (Combination Light & Field Relay)
 Closing Voltage 1-3 Volts @ 80°F
 Location Right side front engine compartment

STARTING SYSTEM

STARTING MOTOR

Rotation (Drive End View) Clockwise
 Test Conditions --- Engine at operating temperature
 No Load Test
 Amps 65-100
 Volts 10.6
 RPM 3600-5100

Motor Drive

Engagement Solenoid
 Pinion Meshes at Rear
 Pinion Tooth No. 9
 Flywheel Tooth No. 133; V8-427 - 168
 Mounting Bolted to clutch housing

IGNITION SYSTEM

DISTRIBUTORS Refer to chart below

IGNITION PULSE AMPLIFIER

(Used with RPO L72 Transistor Ignition System)

COIL

Type 12 Volt
 Amperes Drawn
 Engine Stopped 4.0
 Engine Idling 1.8

SPARK PLUGS

Make & Type
 V8-327 Cu.In. AC44
 V8-427 Cu.In. AC43N
 Thread Size (mm) 14
 Gap033-.038
 Torque 25 lb ft

CABLE Linen core impregnated with electrical conducting material and insulation of rubber with neoprene jacket

●DISTRIBUTORS	V-8 327 Cu.In. Base - 300 HP	V-8 327 Cu.In. RPO L79 - 350 HP	V-8 427 Cu.In. RPO L36 - 390 HP	V-8 427 Cu.In. RPO L72 - 425 HP
Make	Delco-Remy			
Model	1111153	1111156	1111141	1111093
Type	Single Breaker			Transistorized Magnetic Pulse
Cam Angle	28°-32°			
Breaker Gap	.019 (new)			
Breaker Arm Tension	19-23 oz			
Centrifugal Advance Begins (RPM)	900			1000
Max Degrees @ RPM	30 @ 5100			28 @ 4600
Vacuum Advance Begins (In. Hg)	6	4	6	7
Max. Degrees @ In. Hg.	15 @ 12	16 @ 7	15 @ 12	12 @ 12
Timing (Initial Design Setting)	6°	10°	4°	8°
Crankshaft Degrees @ RPM (with vacuum spark line disconnected)	BTC @ 500	BTC @ 700	BTC @ 550	BTC @ 800
Timing Mark Location	Torsional Damper			

CLUTCHES AND TRANSMISSIONS

CLUTCHES

Engine	Type	V-8 327 Cubic Inch		V-8 427 Cubic Inch		
	Availability	Regular Production	RPO L79	RPO L36	RPO L72	
Clutch for		3-Speed & 4-Speed		3-Speed & 4-Speed		
Type		Single dry disk, centrifugal				
Clutch cover & pressure plate	Eff. plate load, lb. @	2100-2300		2450-2750	2600-2700	
	Press. plate matl.	Nodular Iron				
	Clutch spring type	Circular plate diaphragm, beam finger design				
	Clutch spring matl.	Heat treated spring steel				
Driven plate	Type	Single disc with two friction surfaces				
	Cushions	Flat spring steel between friction rings				
	Dampers	10 coil springs (5 sets of two)				
	Friction rings	OD	10.0		10.5	
		ID	6.5		6.5	
		Total area sq. in.	90.7		103.5	
Flywheel	Ring gear	Matl.	Woven type asbestos			
		Matl.	Heat treated HR steel			
	No. of teeth	153		168		
		PD	12.75		14.00	
Bearings	Release	Type	Shrink fit			
		Lubrication	Single row ball			
	Pilot	Type	None, prepacked			
		Lubrication	Bronze bushing			
Controls	Clutch fork	None, sintered and oil impregnated				
	Pedal mounting	Drop forged steel, pivot mounted on ball				
	Lubrication	Pendant, from brace on dash				
Clutch housing material		Crossover shaft				
		Aluminum alloy				

3-SPEED AND 4-SPEED TRANSMISSIONS

Transmission Type	3-Speed	4-Speed RPO M20	4-Speed RPO M21		
Engine	V-8 327 Cu. In.	V-8 327 Cu. In.	V-8 327	V-8 427 Cu. In.	
Application	Std.	RPO L79	RPO L79	RPO L36 RPO L79	
Case material	Cast Iron		Aluminum		
Gear shift	Type	Remote			
	Control	Lever			
	Location	Floor, mounted between seats			
Gears	Type	Helical			
	Material	Forged steel, hardened			
	Synchronization	All forward gears			
	Constant mesh gear	All gears	All forward gears		
	Sliding gears	None	Reverse		
	Ratios	First	2.34	2.52	2.20
		Second	1.50	1.88	1.64
		Third	1.00	1.46	1.27
Fourth		1.00	1.00	1.00	
Reverse		2.63	2.50	2.20	
Lubricant	Type	Meeting Military Specification MIL-L-2105-B			
	Capacity (pts)	2	2.5		
Extension	Material	Aluminum			
	Oil seal	Steel encased double seal of spring loaded rubber or felt			

TRANSMISSIONS—Cont'd.

AUTOMATIC TRANSMISSION (RPO M35)

GENERAL

Type ----- Automatic hydraulic torque converter
with planetary gear system for low and reverse

Selector lever
Location ----- Floor
Operation ----- Actuates manual valve
in hydraulic control system

Selector positions ----- P-R-N-D-L

Parking brake
Type ----- Positive
Operation ----- Applied by selector lever
through spring-loaded linkage

Method of cooling ----- Air heat exchanger

Flywheel assembly ----- Steel stamping with
welded on ring gear

HYDRAULIC CONTROLS

Manual valve type ----- Spool

Pressure regulator valve type ----- Spool

Pressure range, psi @ idle (Conditions: 450 RPM input,
25 inches Hg vacuum)

Drive
Minimum ----- 49
Maximum ----- 53

Low
Minimum ----- 127
Maximum ----- 136

Reverse
Minimum ----- 82
Maximum ----- 88

CONVERTER ASSEMBLY

Type ----- Three element

Pump
Description ----- Sheet steel shells and
vanes; welded to converter housing

Turbine
Description ----- Sheet steel shells and
vanes, supported in converter cover; operation
independent of cover and pump housing

Stator
Description ----- Aluminum str foil supported on a
stationary sleeve by an over-running
clutch of cam and roller design

Shell torque ratio ----- 2.10:1

Shell speed (RPM) ----- 1680

Diameter (nominal) ----- 11.75

PLANETARY GEAR SET

Type ----- Compound planetary

Range
Drive ----- 1.76:1 to 1:1
Low ----- 1.76:1
Reverse ----- 1.76:1

Low band ----- Three linked circular segments

Low band servo ----- Piston with release spring
and inner cushion spring

CASE

Material ----- (One piece) aluminum

OUTPUT SHAFT RPM (VEHICLE SPEED MPH)

N/V factor ----- 42.2

Upshift
Closed throttle ----- 640 (16)
Throttle at detent ----- 2350 (61)
Full detent ----- 2750 (65)

Downshift
Closed throttle ----- 615 (15)
Throttle at detent ----- 885 (21)
Full detent ----- 2590 (61)

HIGH CLUTCH

Type ----- Multi-disk

Drive plates
Description ----- Waved steel
with bonded organic facings

Number ----- 4

Driven plates
Description ----- Flat steel

Number ----- 5

REVERSE CLUTCH

Type ----- Multi-disk

Drive plates
Description ----- Flat steel with
bonded organic facings

Number ----- 6

Driven plates
Description ----- Flat steel

Number ----- 6

TORQUE MULTIPLICATION

Maximum overall ratio ----- 3.70:1

Low and reverse ----- 3.70:1 to 1.76:1

LUBRICANT

Type ----- A, Suffix A

Capacity (pts)
Dry ----- 18
Refill ----- 3

GOVERNOR

Type ----- Centrifugal

Operation ----- Regulates pump oil pressure
to automatic shift control valve

Drive ----- Mounted on output shaft

Location ----- In extension

OIL PUMPS

Type ----- Internal-external gear

Number ----- Two, front and rear

Function ----- To supply pressure

Front pump
Drive ----- Converter pump
Function ----- Supply main system
pressure at low vehicle speeds

Rear pump
Drive ----- Output shaft
Function ----- Supply main system pressure
at high vehicle speeds and during push starts

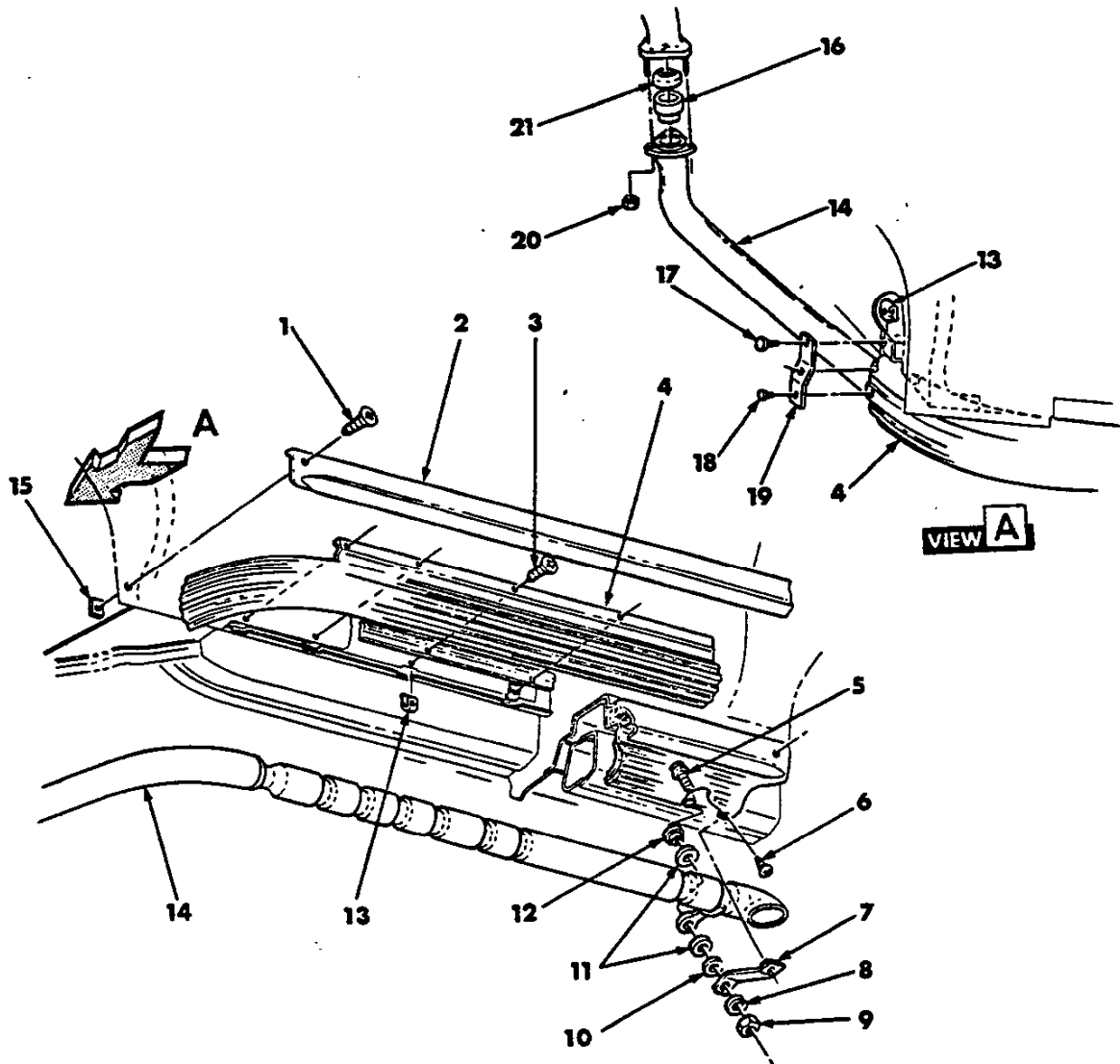

3-197

1965-67 CORVETTE SIDE MOUNTED EXHAUST

- | | |
|---------------------------------|---|
| 1. 8.977 SCREW (#8-18 x 1) | 12. 3.704 RETAINER |
| 2. 8.304 MOULDING | 13. 3.616 "U" NUT (#10-24) |
| 3. 8.977 SCREW (#10-24 x 5/8) | 14. 3.701 MUFFLER |
| 4. 3.602 COVER ASSY. | 15. 8.921 NUT (stamped-#8-15) |
| 5. 8.903 BOLT (3/8-16 x 2-1/4) | 16. 3.609 EXTENSION |
| 6. 8.909 SCREW (#10-8-24 x 5/8) | 17. 8.900 SCREW (w/L/Washer) (#10-24 x 5/8) |
| 7. 3.602 BRACKET | 18. 8.900 SCREW (#10-24 x 7/16) |
| 8. 8.931 L/WASHER (3/8) | 19. 3.602 BRACKET |
| 9. 8.915 NUT (3/8-16) | 20. 8.916 NUT (Hex 3/8-16) |
| 10. 8.929 WASHER (3/8) | 21. 3.611 PACKING |
| 11. 3.704 INSULATOR | |

©1970 CHEVROLET MOTOR DIVISION, GENERAL MOTORS CORPORATION—P&A 30B



•
•
•



1966 CORVETTE/ AND INTERIOR TRIM CHOICES

Interior Trim Codes:		CORVETTE INTERIOR TRIM							
E-Black C-Saddle D-Red B-Dark Blue X-Green Y-Silver R-Bright Blue W-White/Bright Blue		SPORT COUPE AND CONVERTIBLE							
		ALL-VINYL							
EXTERIOR COLORS & CODE	RPO Color	Std.	407	414	418	420	426	430	450
		Black	Red	Bright Blue	Dark Blue	Saddle	Silver	Green	White Bright Blue
Tuxedo Black	900	E	D	R	B	C	Y	X	W
Ermine White	972	E	D	R	B	C	Y	X	W
Rally Red	974	E	D						
Nassau Blue	976	E		R	B				W
Laguna Blue	978	E		R	B				
Trophy Blue	980	E			B				
Mosport Green	982	E						X	
Sunfire Yellow	984	E							
Silver Pearl	986	E					Y		
Milano Maroon	988	E				C			

Interior Trim Codes:		SPORT COUPE AND CONVERTIBLE					
K-Black M-Red N-Dark Blue J-Saddle P-Silver T-Bright Blue		*OPTIONAL LEATHER					
EXTERIOR COLORS & CODE	RPO Color	402	408	419	421	427	415
		Black	Red	Dark Blue	Saddle	Silver	Bright Blue
Tuxedo Black	900	K	M	N	J	P	T
Ermine White	972	K	M	N	J	P	T
Rally Red	974	K	M				
Nassau Blue	976	K		N			T
Laguna Blue	978	K		N			T
Trophy Blue	980	K		N			
Mosport Green	982	K					
Sunfire Yellow	984	K					
Silver Pearl	986	K				P	
Milano Maroon	988	K			J		

*Optional at extra cost

CONVERTIBLE FOLDING TOP for Convertible available in a choice of Black, Beige, or White with any exterior color.



AMA Specifications—Passenger Car

The information contained herein is prepared, distributed by, and is solely the responsibility of the automobile manufacturing company to whose products it relates. Questions concerning these specifications should be directed to the manufacturer whose address is shown below. This uniform specification form was developed by the automobile manufacturing companies under the auspices of the Automobile Manufacturers Association.

MANUFACTURER	Chevrolet Motor Division General Motors Corporation	CAR NAME	Corvette
MAILING ADDRESS	Chevrolet Engineering Center 30003 Van Dyke, Warren, Michigan 48090	MODEL YEAR	1966
		ISSUED:	10-7-65
		REVISED (*)	

NOTES:

1. The Specifications herein are those in effect at date of compilation and are subject to change without notice by the manufacturer.
2. UNLESS OTHERWISE INDICATED:
 - a. Specifications apply to standard models without optional equipment. Significant deviations are noted.
 - b. Nominal design dimensions are used throughout these specifications.

TABLE OF CONTENTS

General Specifications	1,2	Drive Units	14	Suspensions	21
Engine—Mechanical	3	Brakes	18	Weights	24
Electrical	12	Steering	19	Index	25

BODY—TYPES AND STYLE NAMES—

Body type, number of passenger & style names; use manufacturer's code for series & body style.

Model 19437	2-Door Sport Coupe, 2-Passenger
Model 19467	2-Door Convertible, 2-Passenger



AMA Specifications—Passenger Car

MAKE OF CAR CORVETTE MODEL YEAR 1966 DATE ISSUED 10-7-65 REVISED ⁽⁹⁾

GENERAL SPECIFICATIONS

(All dimensions in inches unless otherwise indicated)

MODEL	Additional Information Page No.:	327 Cu. In. V-8 -8		427 Cu. In. V-8	
		300 HP Standard	350 HP RPO L79	390 HP RPO L36	425 HP RPO L72
Wheelbase (L101)		98.0			
Track	Front (W101)	56.8			
	Rear (W102)	57.6			
Maximum Overall Dimensions	Length (L103)	175.1			
	Width (W103)	69.2, 69.6			
	Height (H101)	19437, 49.6; 19467, 49.8			
Transmission (Specify trade name - opt., not available)	Manual - 3 speed	15	Standard		NA
	Manual - 4 speed	15	Optional		Standard
	Overdrive	15	NA		
	Automatic	16	Powerglide Optional	NA	
Axle ratio	Manual - 3 speed	17	3.36:1	NA	NA
	Manual - 4 speed	17	3.36:1	3.36:1	3.08:1 3.55:1
	Overdrive	17	NA		
	Automatic	17	3.36:1	NA	
Tire size	18	7.75 x 15			
Engine	Type, no. cyl., valve arr.	3	90° OHV V-8		
	Fuel system (Carb., other)	10	Carburetor		
	Bore and stroke	3	4.00 x 3.25		4.25 x 3.76
	Piston displ., cu. in.	3	327		427
	Std. compression ratio	3	10.5	11.0	10.25 11.0
	Max. bhp at engine rpm	3	300 @ 5000	350 @ 5800	390 @ 5200 425 @ 5600
	Max. torque at rpm	3	360 @ 3400	360 @ 3600	460 @ 3600 460 @ 4000

* - See page 4 for Optional Axle Ratios.

AMA Specifications—Passenger Car

MAKE OF CAR CORVETTE MODEL YEAR 1966 DATE ISSUED 10-7-65 REVISED ^(*)

GENERAL SPECIFICATIONS—DIMENSIONS

(All dimensions in inches unless otherwise indicated)
(Supplemental data available on request)

MODEL	SAE Ref. No.	19437	19467
-------	--------------	-------	-------

FRONT COMPARTMENT

Shoulder room	W3		48.4
Hip room	W5		50.9
Max. eff. leg room - accelerator	L34		42.7
Effective head room	H61	37.0	38.5
H Point to Heel point	H30		3.9

REAR COMPARTMENT

Shoulder room	W4		
Hip room	W6		NA
Minimum effective leg room	L51		
Effective head room	H63		

LUGGAGE COMPARTMENT

Usable luggage capacity	V1	10.6	8.1
Liftover height	H195		NA
Position of spare tire storage		Under fuel tank (accessible from underside of vehicle)	
Method of holding lid open			NA

STATION WAGON—THIRD SEAT

Hip room	W86		
Effective leg room	L86		NA
Effective head room	H86		
Seat facing direction			

STATION WAGON—CARGO SPACE

MODEL	SAE Ref. No.	
Minimum distance between wheel houses at floor level	W201	
Rear end opening width at belt	W204	
Floor length from back of front seat at floor level to inside of closed tail gate	L202	NA
Minimum horizontal distance from top rear of front seat back to inside of tail gate at belt	L204	
Maximum height - floor covering to headlining at centerline of rear axle	H201	
Maximum height of rear opening - tail and lift gates open	H202	
Cargo volume index (cu. ft.) <u>W4 x L204 x H201</u> 1728	V2	

AMA Specifications—Passenger Car

MAKE OF CAR Corvette MODEL YEAR 1966 DATE ISSUED 10-7-65 REVISED ⁽¹⁾

MODEL 19400 327 Cu. In. V-8 427 Cu. In. V-8
300 HP. Std. 350HP. RPO L79 390HP. RPO L36 425HP. RPO L72

ENGINE—GENERAL

Type, no. cyls., valve arr.	90° OHV V-8			
Bore and stroke (nominal)	4.00 x 3.25		4.25 x 3.76	
Piston displacement, cu. in.	327		427	
Bore spacing (C/L to C/L)	4.84			
No. system	1-3-5-7			
(front to rear)	2-4-6-8			
Firing order	1-8-4-3-6-5-7-2			
Compres. ratio (nominal)	10.5	11.0	10.25	11.0
Cylinder Head Material	Cast Alloy Iron			
Cylinder Block Material	Cast Alloy Iron			
Cylinder Sleeve-Wet, dry, none	None			
Number of mounting points	Two			
Front	One			
Rear	3°			
Engine installation angle	3°			
Taxable horsepower	51.2		57.8	
Di ² xNo.Cyl.	2.5			
Publishing max. bhp* @ eng. RPM	300 @ 5000	350 @ 5800	390 @ 5200	425 @ 5600
Publishing max. torque* (lb. ft. @ RPM)	360 @ 3400	360 @ 3600	460 @ 3600	460 @ 4000
Recommended fuel regular - premium	Premium			
Idle speed(spec. neutral or drive)	Manual	500 In Neutral	700 In Neutral	550 In Neutral
Automatic	500 In Drive	NA		

ENGINE—PISTONS

Material	Cast Alum Alloy	Al. Impact Extrd.	Cast Alum Alloy	Al. Impact Extrd.
Description and finish	Flat Notched Head		Domed Head Valve Cutout	
Weight (piston only) oz.	21.60	20.64	28.00	25.46
Clearance (limits)	Top land	.0365 - .0455	.0395 - .0425	.0305 - .0375
	Skirt	.0005 - .0011(a)	.0039 - .0045(b)	.0009 - .0015(c)
Ring groove depth	Bottom			.0037 - .0043
	No. 1 ring	.2217 - .2283		.2348 - .2413
	No. 2 ring	.2217 - .2283		.2348 - .2413
	No. 3 ring	.2038 - .2103		.2183 - .2248
	No. 4 ring			.2133 - .2148

*Max. bhp (brake horsepower) and max. torque corrected to 60° F and 29.92 in. Hg atmospheric pressure.

- (a) Measured 2.24 from top of piston
- (b) Measured 2.20 from top of piston
- (c) Measured 1.89 from top of piston

AMA Specifications—Passenger Car

MAKE OF CAR Corvette MODEL YEAR 1966 DATE ISSUED 10-7-65 REVISED ⁽¹⁰⁾

POWER TEAMS

(Indicate whether standard or optional)

MODEL AVAILABILITY	ENGINE					TRANSMISSION	AXLE RATIO ^{**}			
	Displ. cu. in.	Carburetor	Compr. Ratio	BHP @ RPM	Torque @ RPM		(Std. first) (Indicate A/C ratio)			
19400	327	4-Bbl	10.5	300	360	3-Speed	3.36	-	3.08	-
				@	@	4-Speed (2.52)*	3.36	-	3.08	-
	4-Bbl*	11.0	350	360	4-Speed (2.52)* 4-Speed (2.20)*	3.36	3.55	-	-	
			@	@						5800
427	4-Bbl*	10.25	390	460	4-Speed (2.52)*	3.08	3.36	-	-	
			@	@	4-Speed (2.20)*	3.36	3.70	3.08	3.55	
427	4-Bbl*	11.0	425	460	4-Speed (2.20)*	3.55	3.70	3.36	4.11	
			@	@						5600

- A General Purpose - Standard
- B Mountain - Optional
- C Economy Cruise - Optional
- D Special Purpose - Optional

* Optional

** Positraction axles available optionally for all standard 300 HP. engine combinations and 350 HP engine with General Purpose axle. All other axle ratios are available as positraction only.

AMA Specifications—Passenger Car

MAKE OF CAR Corvette MODEL YEAR 1966 DATE ISSUED 10-7-65 REVISED ^(*)
 MODEL 19400 327 Cu. In. V-8 427 Cu. In. V-8
 300 HP. Std. 350 HP RPO L79 390 HP RPO L36 425 HP RPO L7

ENGINE—RINGS

Function (top to bottom)	No. 1, oil or comp.	Compression		
	No. 2, oil or comp.	Compression		
	No. 3, oil or comp.	Oil		
	No. 4, oil or comp.	None		
Compression	Description - material, coating, etc.	Cast Alloy Iron, inside bevel Coating - Upper - Chrome plate on Std., Moly. filled groove on remainder (A) Lower - wear resistant on Std. & L36. Chrome plate on L79 & L72		
	Width	.0775 - .0780	.0770 - .0775	.0770 - .0775
	Gap	.013 - .023	.013 - .025	.010 - .020
Oil	Description - material, coating, etc.	Multi-piece 2 rails and one spacer expander) Rails - steel, chrome plated OD Expander - stainless steel		
	Width	.1840 - .1880 (Assembled)		.1830 - .1880 (Assembled)
	Gap	.015 - .055		.010 - .030
Expanders	In oil ring assembly			

ENGINE—PISTON PINS

Material	Chromium Steel			
Length	2.990 - 3.010		2.930 - 2.950	
Diameter	.9270 - .9273		.9895 - .9898	
Type	Locked in rod, in piston, floating, etc.	Locked in rod		
	Bushing	None		
Clearance	In rod or piston			
	In piston	.00015 - .00025	.00045 - .00055	.00025 - .00035
Direction & amount offset in piston	(B)	On center	(B)	On center

ENGINE—CONNECTING RODS

Material	Drop forged steel		High alloy steel	
Weight (oz.)	14.56		27.84	
Length (center to center)	5.699 - 5.701		6.134 - 6.136	
Bearing	Material & Type	Premium aluminum		
	Overall length	.807		
	Clearance (limits)	.0007 - .0027	.0009 - .0025	.0014 - .0030
	End play	.009 - .013		.016 - .020

- (A) - 300 HP Std. Lower consists of one ring and steel expander.
 (B) - Major thrust side .055 - .065.

AMA Specifications—Passenger Car

MAKE OF CAR Corvette MODEL YEAR 1966 DATE ISSUED 10-7-65 REVISED ^(*)
 327 Cu. In. V-8 427 Cu. In. V-8
 MODEL 19400 300HP Std. 350HP RPO L79 390HP RPO L36 425HP RPO L72

ENGINE—CRANKSHAFT

Material		Forged steel			
Vibration damper type		Rubber mounted inertia			
End thrust taken by bearing (No.)		Five			
Crankshaft end play		.006 - .010			
Main bearing	Material & type		Premium aluminum except No. 5 upper is sintered copper nickel backed babbit		
	Clearance		(#1-4).0008-.0034 (#5).0010-.0036	(#1-4).0013-.0029 (#5).0017-.0033	
	Journal dia. and bearing overall length	No. 1	2.3013 x .752	2.7507 x .992	2.7508 x .992
		No. 2	2.3009 x .752	2.7507 x .992	2.7508 x .992
		No. 3	2.3009 x .752	2.7501 x .992	2.7508 x .992
		No. 4	2.3009 x .752	2.7501 x .992	2.7508 x .992
		No. 5	2.3006 x 1.1824	2.7504 x 1.2525	2.7508 x 1.2525
No. 6	None				
No. 7	None				
Dir. & amt. cyl. offset		None			
Crankpin journal diameter		1.999 - 2.000		2.199 - 2.200	

ENGINE—CAMSHAFT

Location		In block above crankshaft		
Material		Cast alloy iron		
Bearings	Material	Steel backed babbit		
	Number	Five		
Type of Drive	Gear or chain		Chain	
	Crankshaft gear or sprocket material		Steel sprocket	
	Camshaft gear or sprocket material		Cast aluminum	
	Timing chain	No. of links	50	
		Width	.880	
Pitch		.500		

ENGINE—VALVE SYSTEM

Hydraulic lifters (Std, opt, NA)		Standard		NA
Valve rotator, type (intake, exhaust)		None		
Rocker ratio		1.50:1		1.70:1
Operating tappet clearance (indicate hot or cold)	Intake	Zero		.024
	Exhaust	Zero		.028
Timing marks on flywheel, damper, other		Torsional Damper		

(Continued)

AMA Specifications—Passenger Car

MAKE OF CAR Corvette MODEL YEAR 1966 DATE ISSUED 10-7-65 REVISED ^(*)
 MODEL 19400 300HP Std. 350HP RPO L79 390HP RPO L36 425HP RPO L72
 327 Cu. In. V-8 427 Cu. In. V-8

ENGINE—VALVE SYSTEM (cont.)

		300HP	350HP RPO L79	390HP RPO L36	425HP RPO L72	
Timing	Intake	Opens (°BTC)	32° 30'	54°	56°	
		Closes (°ABC)	87° 30'	108°	114°	
		Duration-deg.	300°	342°	350°	
	Exhaust	Opens (°BBC)	73° 30'	102°	110°	
		Closes (°ATC)	45° 30'	60°	62°	
		Duration-deg.	300°	342°	352°	
Valve opening overlap		78°	114°	118°	108°	
Material <u>Alloy steel - alumized face; chrome flash stem on RPO L72</u>						
Overall length		4.870	4.889	5.215 - 5.235	5.204 - 5.224	
Actual overall head dia.		1.935 - 1.945	2.017 - 2.023	2.060 - 2.070	2.185 - 2.195	
Angle of seat & face		46° (seat) 45° (face)				
Seat insert material		None				
Stem diameter		.3410 - .3417		.3715 - .3722		
Stem to guide clearance		.0010 - .0027		.0010 - .0027		
Lift (@ zero lash)		.3987	.4472	.4614	.5197	
Intake	Outer spring press. and length	Valve closed (lb. @ in.)	78-85 @ 1.66		94-106 @ 1.88	
		Valve open (lb. @ in.)	170-180 @ 1.26		303-327 @ 1.38	
	Inner spring press. and length	Valve closed (lb. @ in.)	Spring damper			
		Valve open (lb. @ in.)	Spring damper			
Material <u>High alloy steel - alumized face chrome flash stem on RPO L72</u>						
Overall length		4.913 - 4.933	4.891 - 4.910	5.345 - 5.365		
Actual overall head dia.		1.495 - 1.505	1.595 - 1.605	1.715 - 1.725		
Angle of seat & face		46° (seat) 45° (face)				
Seat insert material		None				
Stem diameter		.3410 - .3417		.3713 - .3720		
Stem to guide clearance		.0015 - .0032				
Lift (@ zero lash)		.3937	.4472	.4800	.5197	
Exhaust	Outer spring press. and length	Valve closed (lb. @ in.)	78-86 @ 1.26		94-106 @ 1.88	
		Valve open (lb. @ in.)	170-180 @ 1.26		303-327 @ 1.38	
	Inner spring press. and length	Valve closed (lb. @ in.)	Spring damper			
		Valve open (lb. @ in.)	Spring damper			

ENGINE—LUBRICATION SYSTEM

Type of lubrication (splash, pressure, nozzle)	Component	Lubrication Method
	Main bearings	Pressure
	Connecting rods	Pressure
	Piston pins	Splash
	Camshaft bearings	Pressure
	Tappets	Pressure
	Timing gear or chain	Centrifugally oiled from camshaft bearing
	Cylinder walls	Pressure, jet cross sprayed
		(Continued)

* Values for 300 HP, 350 HP and 400 HP include ramps
 Values for 450 HP are given with lash of .024 intake and .028 exhaust

AMA Specifications—Passenger Car

MAKE OF CAR Corvette MODEL YEAR 1966 DATE ISSUED 10-7-65 REVISED ^(*)
 327 Cu. In. V-8 427 Cu. In. V-8
 MODEL 19400 300HP Std. 350HP RPO L79 390HP RPO L36 425HP RPO L72

ENGINE—LUBRICATION SYSTEM (cont.)

Oil pump type	Gear	
Normal oil pressure (lb. @ engine rpm)	30-45 PSI @ 1500 RPM	50-75 PSI @ 2000 RPM
Oil pressure sending unit (elect. or mech.)	Mechanical (direct pressure to Bourdon Tube)	
Type oil intake (floating, stationary)	Stationary	
Oil filter system (full flow, partial, other)	Full Flow	
Filter replacement (element, complete)	Element	
Capacity of crankcase, less filter-refill (qt.)	5	
Oil grade recommended (SAE viscosity and temperature range)	32° F and above - SAE 20W, SAE 20 or SAE 10W-30 0° F and above - SAE 10W or SAE 10W-30 Below 0° F - SAE 5W or SAE 5W-20	
Engine Service Requirement (MM, MS, etc.)	MS or DG	

ENGINE—EXHAUST SYSTEM

Type (single, single with cross-over, dual, other)	Dual	
Muffler No. & type (reverse flow, straight thru, separate resonator)	Two, reverse flow	
Exhaust pipe dia. (O.D., wall thickness)	Branch	2.50 x .072 - .092
	Main	2.50 x .084 - .104 laminated
Tail pipe diameter (O.D. & wall thickness)	2.00 x .023	

ENGINE—CRANKCASE VENTILATION SYSTEM

Type (ventilates to atmos., induction system, other)	Standard	Induction system
	Optional	
Control Unit	Make and model	
	Location	Carburetor Base
	Energy source (manifold vacuum, carburetor air stream, other)	Carburetor air stream
	Control method (variable orifice, fixed orifice, other)	Fixed orifice
Complete system	Discharges (to intake manifold, carb. air intake, air cleaner intake, other)	Intake manifold
	Air inlet (breather cap, carburetor air cleaner, other)	Filtered side of air cleaner
	Flame arrester (screen, check valve, other)	Screen

* SAE 5W-30 can be used as an alternate for 5W, SW-20 or 10W-30

AMA Specifications—Passenger Car

MAKE OF CAR Corvette MODEL YEAR 1966 DATE ISSUED 10-7-65 REVISED ^(a)

MODEL 19400 300HP Std. 327 Cu. In. V-8 150HP RPO L79 427 Cu. In. 425HP RPO L37

ENGINE—EXHAUST EMISSION CONTROL

Type (Air injection, engine modifications, other)		Air Injection			
Air Injection Pump	Type	Semi-articulated vane type			
	Displacement	19.3 cubic inches			
	Drive ratio	1.25:1			
	Drive type	Crankshaft Pulley			
	Relief valve (type)	Pressure (plate type)			
	Filter (describe)	None (clean air drawn from air cleaner)			
Air Injection System	Air distribution (head, manifold, etc.)	Manifold			
	Point of entry	Exhaust ports			
	Injection tube I.D.	.2565			
	Check valve type	Pressure (plate type)			
Backfire protection (type)	Vacuum actuated anti-backfire valve				
Carburetor	Make	Holley			
	Model	3890499		3892341	
	Barrel size	1.562 Primary & Secondary			
	Idle speed	Drive	500 P/Gld. Tr.	NA	550 Pwr/Gld. Tran.
	Neutral	500 Max. Tr.	700 Max. Tran.	550 Manual Tran.	
Aux. Adv. Systems (type)					
Distributor	Make	De.sco-Remy			
	Model	(a)	1111155	1111156	1111141
	Cent'fgal adv. in crank degrees @ eng. rpm.	Start (rpm)	900		
		Intermed. points deg. @ rpm			
		Max. deg.@rpm.	30 @ 5100	30 @ 5100	30 @ 5000
	Vacuum adv. in. crank degrees @ eng. rpm	Start (in Hg)	5"	4"	6"
		Intermed. points deg. @ in. Hg			
Max. deg. @ in.		15 @ 12"	16 @ 7"	15 @ 12"	
Vacuum Source					
Timing - Crank degrees @ rpm	6° BTDC @ 500	10° BTDC @ 700	4° BTDC @ 550		
Cooling System (describe changes)					
Exhaust System (describe changes)					

(a) Powerglide Model Nos. 327 Cu. In. Std. (1111117)

AMA Specifications—Passenger Car

MAKE OF CAR Corvette MODEL YEAR 1966 DATE ISSUED 10-7-65 REVISED ^(*)
 MODEL 19400 327 Cu. In. V-8 427 Cu. In. V-8
 300HP. Std. 350HP RPO L79 390HP RPO L36 425HP RPO L72

ENGINE—FUEL SYSTEM

(See supplemental page for Details of Fuel Injection, Supercharger, etc. if used)

Induction type: Carburetor, fuel injection, supercharger.		Carburetor	
Fuel Tank	Refill capacity (gals.)	20 (Approximately) (A)	
	Filler location	Center at rear deck	
Fuel Pump	Type (elec. or mech.)	Mechanical	
	Locations	Lower right front of engine	
	Pressure range	5.25-6.50 PSI	5.00-6.50 PSI
Vacuum booster (std., optional, none)		None	
Fuel Filter	Type	Fine mesh plastic strainer in gas tank and sintered bronze filter in carburetor inlet	
	Locations		
Carburetor	Choke type	Automatic	
	Intake manifold heat control (exhaust or water)	Exhaust	
	Air cleaner type	Standard	Oil-wetted paper element
	Optional		

CARBURETOR SUPPLEMENTARY INFORMATION

Model Usage	Engine Displ.	Transmission	Carburetors		No. Used and Type	Barrel Size
			Make	Model		
19400	327 300HP	3-Speed 4-Speed Powerglide	Holley	3884505	One; Four Barrel	1.562 Prim. @ Secn'd.
	327 350HP	3-Speed 4-Speed	Holley	3884508	One; Four Barrel	1.562 Prim. @ Secn'd.
	427 390HP	4-Speed	Holley	3882835	One; Four Barrel	1.562 Prim. @ Secn'd.
	427 425HP	4-Speed	Holley	3886101	One; Four Barrel	1.686 Prim. @ Secn'd.
(A) - 36 gallon fiberglass tank available optionally						

AMA Specifications—Passenger Car

MAKE OF CAR Corvette MODEL YEAR 1966 DATE ISSUED 10-7-65 REVISED ^(*)

MODEL 19400 300HP Std. | 350HP RPO L79 | 390HP RPO L36 | 425HP RPO L

327 Cu. In. V-8 427 Cu. In. V-8

ENGINE—COOLING SYSTEM

Type system (pressure, pressure vented, atmospheric, other)		Pressure with surge tank		
Radiator cap relief valve pressure		15 1/2 PSI		
Circulation thermostat	Type (choke, bypass)	Choke		
	Starts to open at (°F)	177° - 183° F		
Water pump	Type (centrifugal, other)	Centrifugal		
	GPM @ 1000 pump rpm	57 @ 4400	82 @ 5200	
	Number of pumps	One		
	Drive (V-belt, other)	V-Belt		
Bearing type		Double row ball		
By-pass recirculation type (internal, external)		External		
Radiator core type (cellular, tube and fin, other)		Cross flow		
Cooling system capacity	With heater (qt.)	16	23	
	Without heater (qt.)	15	22	
	Opt. equipment-specify (qt.)			
Water jackets full length of cylinder (yes, no)		Yes		
Water all around cylinder (yes, no)		Yes		
Radiator hose	Lower	Number and type (molded, straight)	One, molded	
		Inside diameter	1.75	
	Upper	Number and type (molded, straight)	One, molded	
		Inside diameter	1.50	
	By-pass	Number and type (molded, straight)	None	One, molded
		Inside diameter	None	.725 - .765
Fan	Number of blades & spacing		5, staggered	
	Diameter		17.12	
	Ratio-fan to crankshaft rev.		.949:1	
	Fan cutout type		Thermo-modulated-viscous coupling	
	Bearing type		Double row ball	
*Drive belts (indicate belt used by letter)	Fan	A	DE	GH
	Generator or alternator	A	D	G
	Water Pump	A	DE	GH
	Power Steering	B	F	I
	Air Conditioning	C	C	J

* Drive Belt Dimensions	A	B	C	D	E	F	G	H	I	J	K
Angle of V						38°	42°				
Nominal length (SAE)	53.25	36.25	58.00	54.00	34.40	45.00	56.00	34.40	43.85	47.00	
Width						.380					

AMA Specifications—Passenger Car

MAKE OF CAR Corvette MODEL YEAR 1966 DATE ISSUED 10-7-65 REVISED ^(*)
 MODEL 19400 300HP Std. 350HP RPO L79 390HP RPO L36 425HP RPO L72
 327 Cu. In. V-8 427 Cu. In. V-8

ELECTRICAL—SUPPLY SYSTEM

Battery	Make and Model		Delco-Remy 1983506			
	Voltage Rtg. & Total Plates		12 Volt-66 Plate			
	SAE Designation & Amp Hr. Rtg.		61 Amp/Hr. @ 20 Hr. rate			
	Location		Right Rear Engine Compartment			
Terminal grounded		Negative				
Generator or Alternator	Make		Delco-Remy			
	Model		1100693			
	Type and rating		Diode rectified 9-37 Amps			
	Output at engine idle (neutral)		13 Amps	22 Amps	16 Amps	24 Amps
Ratio—Gen. to Cr/s rev.		2.46:1				
Regulator	Make		Delco-Remy			
	Model		1119515			
	Type		Vibrator			
	Cutout relay	Closing voltage @ generator rpm				
		Reverse current to open				
	Regu- lated	Voltage	13.8-14.8 @ 85°F			
		Current				
Voltage test conditions	Temperature	Operating				
	Load	3-8 Amps				
	Other	None				

ELECTRICAL—STARTING SYSTEM

Starting motor	Make		Delco-Remy			
	Model		1107320		1107352	
	Rotation (drive end view)		Clockwise			
	Engine cranking speed					
	Test conditions		Engine at operating temperatures			
	No load test	Amps	65-100			
Volts		10.6				
RPM (min)		3600-5100				
Switch (solenoid, manual)		Solenoid				
Motor control	Starting procedure		3-Spd & 4-Spd --- Place gearshift in neutral & depress clutch to floor. Powerglide --- Place control lever in "N" or "P" position. Initial Start --- Press accelerator pedal to floor once to set automatic choke, then release. Turn ignition to START-release as soon as engine starts.			

(Continued)

AMA Specifications—Passenger Car

MAKE OF CAR Corvette MODEL YEAR 1966 DATE ISSUED 10-7-65 REVISED ^(*)

	396 Cu. In. V-8	427 Cu. In. V-8
MODEL <u>19400</u>	325 HP. RPO L35	350 HP. RPO L79
	390 HP. RPO L36	425 HP. RPO L72

ELECTRICAL—STARTING SYSTEM (cont.)

Motor Drive	Engagement type		Positive shift solenoid		
	Pinion meshes (front, rear)		Rear		
	Number of teeth	Pinion	9		
		Flywheel	Manual	153	168
	Flywheel tooth face width	Manual	Auto.	153	NA
			Manual	.4010 - .4130	.4100 - .4220
Auto.	4010 - .4130		NA		

ELECTRICAL—IGNITION SYSTEM

Coil	Transistorized - Std., Opt., N.A.		Optional	Mandatory	
	Make		Delco-Remy		
	Model		1115202	1115210	
Amps	Engine stopped		4.0		
	Engine idling		1.8		
Distributor	Make		Delco-Remy		
	Model		1111153	1111156	
	Cent'fgal adv. in crankshaft degrees @ engine rpm (nominal)	Start (rpm)	900		
		Intermediate points deg. @ rpm.			
	Max. deg. @ rpm.	30 @ 5100	30 @ 5100	30 @ 5000	28 @ 4600
		Vacuum adv. in crankshaft degrees @ in. Hg. (nominal)	Start (in. Hg.)	6"	4"
	Intermediate points, deg. @ in. Hg.	6"	4"	6"	6"
		Max. deg. in. Hg.	15 @ 12"	16 @ 7"	15 @ 12"
	Breaker gap (in.)	.019			
	Cam angle (deg.)	23° - 32°			
Breaker arm tension (oz.)	19 - 23 oz				
Timing	Crankshaft deg. @ rpm.	8° BTDC @ 500	10° BTDC @ 700	4° BTDC @ 550 8° BTDC @ 800	
	Mark location	Torsional Damper			
Spark Plug	Make		AC Spark		
	Model		AC 44	AC 43N	
	Thread (mm)		14		
	Tightening torque (lb. ft.)		25		
	Gap		.033 - .038		
Cable	Conductor type		Linen core impregnated with electrical conducting mater.		
	Insulation type		Rubber with neoprene jacket		
	Spark plug protector		Hypalon jacket		

AMA Specifications—Passenger Car

MAKE OF CAR Corvette MODEL YEAR 1966 DATE ISSUED 10-7-66 REVISED ^(*)

MODEL 19400 396 Cu. In. V-8 427 Cu. In. V-8
325HP RPO L35 | 350HP RPO L79 | 390HP RPO L36 | 425HP RPO L72

ELECTRICAL—SUPPRESSION

Locations & type

Non-Metallic High
Tension Ignition Cables

ELECTRICAL—INSTRUMENTS AND EQUIPMENT

Speed-ometer	Make	AC
	Trip odometer (yes, no)	Yes
Charge indicator—type		Ammeter
Temperature indicator—type		Electric gage
Oil pressure indicator—type		Bourdon tube gage
Fuel indicator—type		Electric gage
Other		Mechanical tachometer
Windshield wiper	Make	Delco
	Type—Standard	Electric two speed
	Type—Optional	None
	Vacuum booster provision	None
	Washer provision	None
Horn	Type	Vibrator
	Number used	2
	Amp draw (each)	8.00-11.00 @ 12.5 V

DRIVE UNITS—CLUTCH (Manual Transmission) 3-Speed & 4-Speed

Make & type	Chevrolet, single dry disc, centrifugal		
Type pressure plate springs	Circular plate diaphragm, bent finger design		
Total spring load (lb.)	2100-2300	2300-2600	2600-2800
No. of clutch driven discs	One		
Clutch facing	Material	Woven type asbestos	
	Outside & inside dia.	10.0 & 6.5	10.5 & 6.5
	Total eff. area (sq. in.)	90.7	103.5
	Thickness	1.35 each	
	Engagement cushioning method	Flat spring steel between cushions	
Release bearing	Type & method of lubrication	Single row ball, packed and sealed	
Torsional damping	Methods: springs, friction material	Coil springs	

A.M.A Specifications—Passenger Car

MAKE OF CAR <u>Corvette</u>	MODEL YEAR <u>1966</u>	DATE ISSUED <u>10-7-65</u> REVISED ^(*)									
MODEL <u>19400</u>	<table border="1" style="width:100%; border-collapse: collapse;"> <tr> <td style="width:33%; text-align:center;">327 Cu. In. V-8</td> <td style="width:33%; text-align:center;">350 HP RPO L79</td> <td style="width:33%; text-align:center;">427 Cu. In. V-8</td> </tr> <tr> <td style="text-align:center;">300 HP Std.</td> <td style="text-align:center;">350 HP RPO L79</td> <td style="text-align:center;">RPO L36</td> </tr> <tr> <td style="text-align:center;">3-Spd. 4-Spd.</td> <td style="text-align:center;">4-Spd. 4-Spd.</td> <td style="text-align:center;">4-Spd. 4-Spd. 4-Spd.</td> </tr> </table>	327 Cu. In. V-8	350 HP RPO L79	427 Cu. In. V-8	300 HP Std.	350 HP RPO L79	RPO L36	3-Spd. 4-Spd.	4-Spd. 4-Spd.	4-Spd. 4-Spd. 4-Spd.	
327 Cu. In. V-8	350 HP RPO L79	427 Cu. In. V-8									
300 HP Std.	350 HP RPO L79	RPO L36									
3-Spd. 4-Spd.	4-Spd. 4-Spd.	4-Spd. 4-Spd. 4-Spd.									

DRIVE UNITS—TRANSMISSIONS

Manual 3-speed (std. or opt.)	Standard	NA
Manual 4-speed (std. or opt.)	Optional	Standard
Manual with overdrive (std. or opt.)	NA	
Automatic (std. or opt.)	Powerglide optional with 300 HP. only	

DRIVE UNITS—MANUAL TRANSMISSION

Number of forward speeds		3	4				
Transmission ratios	In first	2.54	2.52	2.20	2.52	2.20	
	In second	1.50	1.88	1.64	1.88	1.64	
	In third	1.00	1.46	1.27	1.46	1.27	
	In fourth		1.00	1.00	1.00	1.00	
	In reverse	2.63	2.59	2.26	2.59	2.26	
Synchronous meshing, specify gears		All forward gears					
Shift lever location		Floor mounted					
Lubricant	Capacity (pt.)	2	2.5				
	Type recommended	Military spec. Mil-L-2105-B					
	SAE viscosity number	Summer	SAE 80				
		Winter	SAE 80				
		Extreme cold	SAE 80				

DRIVE UNITS—MANUAL TRANSMISSION WITH OVERDRIVE

For transmission data see manual transmission section

Type (planetary or other)						
Manual lockout (yes, no)						
Downshift accelerator control (yes, no)						
Minimum cut-in speed						
Gear ratio		Not Available				
Lubricant	Capacity (pt.) (Overdrive only)					
	Separate filler (yes, no)					
	Type recommended					
	SAE viscosity number	Summer				
		Winter				
Extreme cold						

AMA Specifications—Passenger Car

MAKE OF CAR Corvette MODEL YEAR 1966 DATE ISSUED 10-7-65 REVISED ^(a)

MODEL 19400

DRIVE UNITS—AUTOMATIC TRANSMISSION Available with 300 HP. standard engine only

Trade name	Powerglide	
Type describe	Torque converter with planetary gears	
Method of Selection (Lever, Push Button or other)	Lever (floor mounted)	
Selector Pattern	P-R-N-D-L	
List gear ratios Selector Pattern and indicate which are used in each selector position	Drive 1.76 to 1.1 Low & Reverse 1.76	
Max. upshift speeds—drive range	65	
Max. kickdown speeds—drive range	61	
Torque convertor	Number of elements	3
	Max. ratio at stall	2.10
	Type of cooling (air, liquid)	Air
Lubricant	Capacity—refill (pt.)	3
	Type recommended	A suffix A
Special transmission features		

DRIVE UNITS—PROPELLER SHAFT

Number used	One	
Type (exposed, torque tube)	Tubular, exposed	
Outer diameter x length* x wall thickness	Manual 3-speed transmission	2 X 29.90 X .095
	Manual 4-speed transmission	2 X 29.90 X .095
	Overdrive transmission	NA
	Automatic transmission	2 X 29.90 X .095

* Center to center of universal joints, or to centerline of rear attachment.

(Continued)

AMA Specifications—Passenger Car

MAKE OF CAR CORVETTE MODEL YEAR 1966 DATE ISSUED 10-7-65 REVISED ^(*)

MODEL _____

DRIVE UNITS—PROPELLER SHAFT (cont.)

Intermediate bearing	Type (plain, anti-friction)	None
	Lubrication (fitting, prepack)	
Universal joints	Make	Chevrolet
	Number used	2
	Type (ball and trunnion, cross, other)	Cross
	Bearing	Type (plain, anti-friction)
Lubric. (fitting, prepack)		Prepack
Drive taken through (torque tube or arms, springs)		Torque control arms
Torque taken through (torque tube or arms, springs)		Torque control arms

DRIVE UNITS—REAR AXLE

Description	Semi-floating, overhung pinion gear		
Limited Slip differential, type	Dual disc clutches		
Drive Pinion Offset	1.5		
No. of differential pinions	2		
Ring gear O.D. (std. ratio)	8.375		
Pinion adjustment (shim, other)	None		
Pinion bearing adj. (shim, other)	Shim		
Wheel bearing type	Taper roller		
Lubricant	Capacity (pt.)	3.7	
	Type recommended	Military Spec. MIL-L-2105-B	
	SAE viscosity number	Summer	SAE 80
		Winter	SAE 80
		Extreme cold	SAE 80

REAR AXLE RATIO TOOTH COMBINATIONS

(See page 4 for axle ratio usage)

Axle ratio	3.36	3.70
No. of teeth	Pinion	11
	Ring gear	37

AMA Specifications—Passenger Car

MAKE OF CAR CORVETTE MODEL YEAR 1966 DATE ISSUED 10-7-65 REVISED ⁽⁶⁾

MODEL _____

DRIVE UNITS—WHEELS

Type & material		Short spoke disc, steel
Rim (size and flange type)	Std.	15 x 5.5K
	Opt.	15 x 6L, integral ribbed aluminum casting
Attachment	Type (bolt or stud)	15 x 5.5K, bolt; 15 x 6L, adapter & spinner cap
	Circle diameter	4.75
	Number and size	15 x 5.5K, 5 hex nuts, 7/16-20 UNF-2B; 15 x 6L, 2-5/8-8 UN-2B

DRIVE UNITS—TIRES

Standard (List option below)	Size & ply	7.75 x 15-4PR, highway tubeless, BW
	Type - Nylon, etc.	Rayon
Rev./mile at 50 mph.		776
Inflation press. (cold)	Front	24
	Rear	24
Optional tires - size and ply		7.75 x 15-4PR, rayon, W/W 7.75 x 15-4PR (4 ply) nylon (gold stripe)

BRAKES—SERVICE

Type (duo-servo, disc, balanced, etc.)		Caliper disc, 4-wheel hydraulic
Self adjusting (std., opt., N.A.)		None required
Hydraulic system type (single, dual, etc.)		Single
Power brake make & type (remote, integral, etc.)		Delco-Moraine vacuum power unit assists master cylinder: integral
Effective area (sq. in.) *		
Gross lining area (sq. in.) **		
Swept drum area (sq. in.) ***		461.2
Percent brake effectiveness—front		65.0
Drum or Rotor	Diameter	Front Disc 11.75 Rear Disc 11.75
	Type and material	Cast iron
	Rotor (vented or solid)	Vented
	No. pistons per caliper	4
Wheel cyl- inder bore	Front	1.875
	Rear	1.375
Master cylinder bore		1.00
Available pedal travel		5.00
Line pressure at 100 lb. pedal load		500
Shoe clearance adjustment		None required

* Excludes rivet holes, grooves, chamfers, etc.

** Includes rivet holes, grooves, chamfers, etc.

*** Total swept area for four brakes:

Widest lining contact width for each brake x its drum circumference.

(Continued)

AMA Specifications—Passenger Car

MAKE OF CAR CORVETTE MODEL YEAR 1966 DATE ISSUED 10-7-65 REVISED ⁽¹⁰⁾

MODEL _____

BRAKES—SERVICE (cont.)

Brake lining	Drum or Disc		Disc		
	Bonded or riveted		Riveted		
	Front Wheel	Material		Woven asbestos	
		Size (length x width x thickness)	Prim. or out-board		
			Second. or in-board		
		Segments per shoe		One per wheel	
	Rear Wheel	Material		Woven asbestos	
		Size (length x width x thickness)	Prim. or out-board		
Second. or in-board					
Segments per shoe		One per wheel			

BRAKES—PARKING

Type of control		Mechanical
Location of control		T handle at right of steering column
Operates on		Rear wheels
If separate from service brakes	Type (internal or external)	Internal
	Drum diameter	6.5
	Lining size (length x width x thickness)	6.77 x 1.25 x .175

FRAME

Type and description (Separate frame, unitized frame, partially - unitized frame)

All welded, full length, ladder constructed frame with 5 crossmembers. Side rails and intermediate crossmembers box construction; rear crossmember "C" shaped. Front crossmember box-girder construction.

STEERING

Manual (std., opt., NA)		Standard		
Power (std., opt., NA)		Optional		
Adjustable steering wheel (tilt, swing, other)	Type and description	Telescoping steering column, driver adjustable		
	(std., opt., NA)	Optional		
Wheel diameter	Manual	16.0		
	Power	16.0		
Turning diameter	Outside front	Wall to wall (l. & r.)	41.6	
		Curb to curb (l. & r.)	39.9	
	Inside rear	Wall to wall (l. & r.)	25.6	
		Curb to curb (l. & r.)	25.6	
Outside wheel angle with inside wheel at 20°		18.5°		
Manual	Gear	Type	Semi-reversible, recirculating ball nut	
		Make	Saginaw	
	Ratios	Gear	16.0:1	
		Overall	Street, 20.2:1	Fast, 17.6:1
No. wheel turns		Street, 3.4	Fast, 2.92	

(Continued)

AMA Specifications—Passenger Car

MAKE OF CAR CORVETTE MODEL YEAR 1966 DATE ISSUED 10-7-65 REVISED ^(A)

MODEL _____

STEERING (cont.)

Power	Type (coaxial, linkage, etc.).		Linkage	
	Make		Saginaw	
	Gear	Type	Same as manual	
		Ratios	Gear	16.0:1
	Overall		17.6:1	
	Pump driven by		Crankshaft pulley	
Number wheel turns		2.92		
Linkage	Type		Parallelogram	
	Location (front or rear of wheels, other)		Rear	
	Drag link (trans. or longit.)		None	
	Tie rods (one or two)		Two	
Steering Axis	Inclination at camber (deg.)		6-1/2 to 7-1/2	
	Bearings (type)	Upper	Ball stud with non-metallic bearing surfaces	
		Lower	Ball stud with non-metallic bearing surfaces	
		Thrust	None	
Wheel Alignment (range at curb weight and preferred) (A)	Caster (deg.)		P1/2 to P1-1/2	
	Camber (deg.)		P1/4 to P1-1/4	
	Toe-in (outside track inches)		3/16 to 5/16 total	
Steering spindle & joint type		Steering knuckle with spherical joints		
Wheel spindle	Diameter	Inner bearing	1.2493-1.2498	
		Outer bearing	.7492-.7497	
	Thread size		3/4-20 NEF-3 (Mod)	
	Bearing type		Taper roller	

(A) Rear wheel alignment; camber N0 to P1; toe-in 1/16 to 3/16 total

AMA Specifications—Passenger Car

MAKE OF CAR CORVETTE MODEL YEAR 1966 DATE ISSUED 10-7-65 REVISED ^(*)MODEL 327 V-8 427 V-8**SUSPENSION—GENERAL**

(See Supplemental page for details on Air Suspension)*

Provision for car leveling	Front stabilizer bar	
Provision for brake dip control	Mounting angle of front upper control arm	
Provision for acc. squat control	None	
Special provisions for car jacking	Front: 5" forward of front edge of door opening, under frame Rear: 3" forward of wheel opening, under frame.	
Shock absorber: front & rear	Type	Direct, double-acting, hydraulic, with freon envelope
	Make	Delco
	Piston dia.	1.00
Other special features	Full independent rear suspension; variable rate front spring	

SUSPENSION—FRONT

Type and description	Independent: SLA type with coil spring and concentric shock absorber, and spherically-jointed steering knuckle for each wheel.	
Spring	Type	Coil, variable rate
	Material	Steel alloy
	Size (coil design height & I.D.; bar length x dia.)	8.56 x 3.80 (theo); 168.50 x 6.00 (theo)
	Spring rate (lb. per in.)	195
	Rate at wheel (lb. per in.)	80
Stabilizer	Type (link, linkless, frameless)	Link
	Material & bar diameter	.750 .875

SUSPENSION—REAR

Type and description	(A)		
Drive and torque taken through	Torque control arms		
Spring	Type	Multi-leaf	
	Material	Chrome carbon steel	
	Size (length x width, coil design height & I.D.; bar length & dia.)	46.36 x 2.25	
	Spring rate (lb. per in.)	140	
	Rate at wheel (lb. per in.)	123	
	Mounting insulation type	Rubber mtd. at diff.; vertical loading only at shackles	
	If leaf	No. of leaves	9
Stabilizer	Type (link, linkless, frameless)	None Link	
	Material	-- .562	
Track bar type	None		

(A) Full independent with fixed differential, transverse multi-leaf spring, lateral struts and universally-jointed axle shafts.

AMA Specifications—Passenger Car

MAKE OF CAR CORVETTE MODEL YEAR 1966 DATE ISSUED 10-7-65 REVISED ^(a)

MODEL 19437 19467

BODY—MISCELLANEOUS INFORMATION

Drs. hinged (front, rear)	Front doors	Front
	Rear doors	NA
Type of finish (lacquer, enamel, other)		Lacquer
Hood counterbalanced (yes, no)		No
Hood release control (internal, external)		Internal
Vehicle Ident. No. location		1--Right side of hinge pillar cross brace, under glove box 2--With engine no.
Engine No. location		Front right side of cylinder block
Theft protection - type		Outside door key locks
Vent window control method (crank, friction pivot)	Front	Crank
	Rear	NA
Seat cushion type	Front	Bucket-polyurethane padding
	Rear	NA
	3rd seat	NA
Seat back type	Front	Bucket-polyurethane padding
	Rear	NA
	3rd seat	NA
Windshield glass type (i.e., single curved - laminated plate)		Single curved-laminated safety plate
Side glass type (i.e., curved - tempered plate)		Compound curved-solid safety plate
Backlight glass type (i.e., compound curved - tempered plate, three piece)		19467 Soft top, flat flexible plastic, 1-piece 19467 Hardtop, curved plexiglass, 1-piece 19437 Compound curved, solid safety plate, 1-piece
Windshield glass exposed surface area		789.7
Side glass exposed surface area		620.1 550.1
Backlight glass exposed surface area		821.5 440.5
Total glass exposed surface area		2231.3 1780.3

LAMP HEIGHT AND SPACING

Height above ground to center of bulb	Headlamp	Highest *	24.4
		Lowest	24.4
	Tail	Highest	21.8
		Lowest	21.8
Distance from C/L of car to center of bulb	Headlamp	Inside	15.4
		Outside *	21.7
	Tail	Inside	19.0
		Outside	24.0
	Directional	Front	28.3
		Rear	19.0, 24.0

* If single headlamps are used enter here.

AMA Specifications—Passenger Car

MAKE OF CAR CORVETTE MODEL YEAR 1966 DATE ISSUED 10-7-65 REVISED ⁽⁰⁾

MODEL _____ 19437 _____ 19467

CONVENIENCE EQUIPMENT

(Indicate whether standard, optional or NA on each series)

Power windows	Side Windows	Optional
	Vent Windows	NA
	Backlight or tailgate	NA
Power seats (specify type as well as availability)		NA
Reclining front seat back		NA
Front seat headrest		Optional
Radios (specify type as well as availability)		AM-FM pushbutton, all models
Rear seat speaker		NA
Power Antenna		Included with radio option
Clock		Standard
Air Conditioner (specify type and availability)		Four seasons, all models
Speed warning device		NA
Speed control device		NA
Ignition lock lamp		Standard
Back up lamp		Standard
Dome lamp		Standard NA
Glove compartment lamp		Standard
Prkg. brake signal lamp		Standard
Luggage compartment lamp		NA
Underhood lamp		NA
Courtesy lamp		Standard
Map lamp		NA
Auto. trans. quad. lamp		NA
Emergency flasher lamp		Optional
Cornering light lamp		NA
Instrument Panel Pad		Standard
Padded Sun Shades		Standard
Left Hand Outside Mirror		Standard

INDEX

SUBJECT	PAGE NO.	SUBJECT	PAGE NO.
Automatic Transmission	1, 16	Linings - Clutch, Brake	14, 18, 19
Axis, Steering	20	Lubrication	7, 8, 14, 15, 16, 17
Axle, Rear	1, 17	Luggage Capacity	2
Battery	12	Motor, Starting	12
Bearings, Engine	5, 6, 7	Muffler	8
Belts - Fan, Generator, Water Pump	11	Overdrive	15
Body - General Information, types	Title, 1, 2, 22	Piston Pins & Rings	3, 5
Exterior Dimensions	1	Pistons	3, 5
Interior Dimensions	2	Power Brakes	18
Brakes - Parking, Service, Power	18, 19	Power Steering	19
Camber	20	Power Teams	4
Car. shaft	6	Propeller Shaft, Universal Joints	16, 17
Capacities		Pumps - Oil, Fuel	8, 10
Cooling System	11	Water	11
Fuel Tank	10	Radiator, Hoses	11
Lubricants		Ratios - Axle	1, 4, 17
Engine Crankcase	8	Compression	1, 3, 4
Transmission and Overdrive	15, 16	Steering	19, 20
Rear Axle	17	Transmission	15, 16
Carburetor	4, 9, 10	Rear Axle	1, 4, 17
Caster	20	Regulator - Generator	12
Choke, Automatic	10	Rims	18
Clutch - Pedal Operated	14	Rings, Piston	5
Coil, Ignition	13	Rods - Connecting	5
Connecting Rods	5	Shock Absorbers, Front & Rear	21
Convenience Equipment	23	Spark Plugs	13
Cooling System	11	Speedometer	14
Crankcase Ventilation	8	Springs - Front & Rear Suspension	21
Crankshaft	5	Valve, Engine	6
Cylinders and Cylinder Head	3	Stabilizer (Sway Bar) - Front & Rear	21
Distributor - Ignition	13	Starting Motor	12
Electrical System	12, 13, 14	Steering	19, 20
Engine		Suppression - Ignition, Radio	14
Bore, Stroke, Displacement, Type	1, 3	Suspension - Front & Rear	21
Compression Ratio	1, 3	Tailpipe	11
Firing Order, Cylinder Numbering	3	Thermostat, Cooling	11
General Information, H.P. & Torque	1, 3	Timing, Engine & Valve	6, 7, 13
Lubrication	7, 8	Tires	1, 18
Power Teams	4	Toe in	20
Exhaust Emission Control	9	Torque Converter	16
Exhaust System	8	Torque - Engine, Rated	1, 3, 4
Equipment Availability	22	Transmission - Types	1, 4, 10, 15, 16
Fan, Cooling	11	Automatic	1, 4, 10, 15, 16
Filters - Engine Oil, Fuel System	8, 10	Manual & Overdrive	1, 4, 10, 15
Frame	19	Ratios	15, 16
Front Suspension	21	Track	1
Fuel, Fuel Pump, Fuel System	1, 3, 10	Trunk Luggage Capacity	2
Fuel Injection	1, 10	Turning Diameter	1
Generator and Regulator	12	Unitized Construction	1
Glass	22	Universal Joints, Propeller Shaft	16, 17
Height (Lamps)	14	Valves - Intake & Exhaust	6
Headroom - Body	2	Vibration Damper	1
Heights - Overall	1	Voltage Regulator	1
Horns	14	Water Pump	1
Horsepower - Brake	1, 3, 4	Weights - Shipping, Curb	2
Ignition System	13	Wheel Alignment	2
Inflation - Tires	18	Wheelbase	1
Instruments	8, 14	Wheels & Tires	1
Kingpin (Steering Axis)	20	Wheel Spindle	2
Lamp Height & Spacing	22	Widths - Car & Body	1
Legroom	2	Windshield	2
Lengths - Overall	1	Windshield Wiper	2
Lifters, Valve	6		

